



l'azienda

Bieffe è stata **fondata nel 1988** dal Sig. Luciano Farinelli. Nel corso degli anni, l'azienda ha affinato la sua specializzazione nella produzione di generatori di vapore per lo stiro e la pulizia.

Attualmente, i nostri generatori di vapore sono impiegati con successo in una vasta gamma di contesti, tra cui **ristoranti, hotel, lavanderie, supermercati e strutture mediche**. In aggiunta, offriamo soluzioni specifiche per settori quali **spa, studi odontotecnici, autolavaggi, toelettatura equina, calzolai**.

Tutti i nostri prodotti sono frutto di un processo di progettazione e sviluppo interno, guidato dal Sig. Farinelli insieme ai nostri ingegneri e supportato dall'esperienza e dai feedback dei nostri clienti.

Ogni componente è 100% made in Italy, le caldaie in rame e le resistenze sono prodotte internamente, garantendo un controllo totale sulla qualità e l'affidabilità delle nostre macchine.

La reputazione dei nostri prodotti è testimoniata dalla loro sicurezza e durata nel tempo; molte delle nostre macchine sono in uso presso i nostri clienti da oltre 20 anni. Attualmente, **esportiamo in oltre 30 paesi, attraverso una rete di circa 3800 rivenditori**.

Nonostante le sfide economiche degli ultimi anni, la Bieffe ha sempre dimostrato una continua crescita. Di recente, abbiamo ampliato la nostra struttura con l'acquisto di un nuovo capannone di 1800 metri quadrati, dedicato allo sviluppo di nuove linee di produzione.

Siamo orgogliosi di offrire **prodotti di alta qualità**, caratterizzati da facilità d'uso e **rispetto per l'ambiente e la sicurezza**, e continuiamo a impegnarci per soddisfare al meglio le esigenze dei nostri clienti.

LA PULIZIA A VAPORE

Il vapore, impiegato all'inizio dell'800 per sviluppare energia meccanica, viene poi riscoperto come fonte di pulizia economica. Il vapore continua ad innescare nuovi processi comportamentali e culturali unendo ecologia, economia, sicurezza e salute.

Steam cleaning

The cleaning efficacy of steam primarily relies on its heat. When utilizing steam cleaning machines, the need for detergents becomes superfluous, resulting in significant cost savings.

IL SUO SUCCESSO

Le chiavi del suo successo risiedono nell'efficacia di pulizia e igienizzazione senza pari, unite a una riduzione dell'impiego di detersivi e dei consumi energetici.

Its success

In daily use, the steam provides enormous benefits and contributes to environmental preservation. Its success is effective cleaning and sanitizing combined with a reduction of energy consumption and the use of detergents.

LA TECNOLOGIA

Si tratta del principio del vapore a secco, portato ad una temperatura compresa tra i 120 e 170°C. A questa temperatura, il vapore riesce a sprigionare un'incredibile potenza che combatte lo sporco profondo e i microrganismi senza danneggiare ambiente e tessuti.

Technology

This is the principle of dry steam, heated to a temperature ranging between 120 and 170°C. At this temperature, the steam releases incredible power to combat deep-seated dirt and microorganisms without harming the environment or fabrics.

I TRE FATTORI

Il vapore secco agisce grazie a tre fattori: la temperatura, che è in assoluto quello principale, la micro-umidità residua, la quale funge da solvente e trattiene i residui di polvere che possono essere rimossi successivamente con un sistema di aspirazione come "Emilio", la pressione, che aumenta l'efficacia pulente in profondità.

Three key factors

The temperature, which is in absolute the main one; the micro residual moisture, which acts as a solvent and retains the powder residue that can then be removed by wiping or directly vacuuming with the "Emilio" system; the pressure, which increases the cleaning effectiveness in depth.

UCCIDIAMO MICROBI E BATTERI

La pressione e l'elevata temperatura uccidono microbi, batteri e i più comuni allergeni, scongiurando il rischio di allergie e altre patologie connesse all'utilizzo di detersivi chimici.

Kill microbes and bacteria

Pressure and high temperature kill microbes, bacteria, and the most common allergens, avoiding the risk of allergies and other illnesses related to the use of chemicals.

RISPETTO DELL' AMBIENTE E RICICLO

La pulizia a vapore riduce il consumo di acqua rispetto ad altri metodi di pulitura (si stima la produzione di 1000 litri di vapore per ogni litro d'acqua) e non implica l'utilizzo di alcun detersivo chimico.

A healthy future

The steam cleaning reduces water consumption compared to other cleaning methods (it is estimated the production of 1000 liters of steam per liter of water) and does not imply the use of any chemical detergent.

UN FUTURO SANO PER I NOSTRI FIGLI

La pulizia a vapore non necessita di prodotti chimici aggiuntivi, a vantaggio di coloro che sono sensibili alle sostanze chimiche o vogliono ridurre il livello di tossicità nelle loro case, soprattutto in presenza di bambini.

A healthy future

Steam cleaning does not require additional chemicals to the benefit of those who are sensitive to chemicals or want to reduce the level of toxicity in their homes, especially in the presence of children.

PERCHÉ BIEFFE

I componenti utilizzati nella realizzazione dei prodotti BIEFFE sono riciclabili al 98% e sono tutti strettamente italiani.

Why Bieffe

The components used in the manufacture of products BIEFFE are 98% recyclable and are all strictly Italian.

QUALITÀ Made In Italy

Il 100% dei componenti delle macchine è prodotto in Italia. Bieffe coopera da molti anni con i migliori fornitori italiani. Le caldaie e le resistenze, i componenti più importanti delle macchine, sono prodotte internamente all'azienda sotto rigoroso controllo.

Tutte le macchine vengono montate all'interno dell'azienda Bieffe, situata a Pesaro, Italia. Dopo il montaggio, tutti i prodotti vengono attentamente controllati per garantirne il corretto funzionamento. I prodotti finiti vengono spediti dall'Italia a oltre 30 paesi nel mondo.

PERCHÈ SCEGLIERE MACCHINE A VAPORE BIEFFE

- Affidabilità e sicurezza garantiti dalla caldaia in rame - materiale antideflagrante e anticalcare - e dalla resistenza esterna mai a contatto con l'acqua;
- Garantiamo ricambistica, accessori e assistenza telefonica in tempi brevissimi;
- Da oltre 30 anni produciamo generatori di vapore, con oltre 500.000 macchine vendute in tutto il mondo;
- Da sapere che 1 kW di potenza genera una portata vapore di 1,3 kg/ora, l'efficacia del vapore è proporzionale alla sua portata, non alla sua pressione. È inutile avere tanta pressione e poca portata;
- L'intera produzione avviene in Italia nel nostro stabilimento di Pesaro.



PRODOTTI SICURI E DURATURI



• Caldaie in rame

La caldaia è in rame, materiale antideflagrante (non può esplodere e, in caso di eventuale rottura, non subisce una perdita di componenti).



• Resistenze esterne

Le resistenze sono esterne alla caldaia perciò, non essendo a contatto con l'acqua, non possono essere corrose dal calcare.



• Raccorderia in teflon

I componenti elettromeccanici sono montati senza colla. Una fasciatura in teflon è usata per la raccorderia. Tutti i componenti delle macchine si possono smontare e sostituire facilmente.

CONTROLLO QUALITÀ

Durante l'assemblaggio, tutte le macchine Bieffe vengono scrupolosamente controllate e testate, così come tutti i suoi pezzi di ricambio. Questo garantisce la sicurezza, l'alta qualità e la durata nel tempo.



RICAMBI REPERIBILI

Bieffe si adatta sempre alle preferenze del cliente e non usa componenti di particolare manifattura, così che tutte le parti di ricambio possono essere facilmente reperite sul mercato.

INDICE DI RIPARABILITÀ

Da sempre la nostra azienda progetta e costruisce macchine pensando alla semplicità delle riparazioni, garantendo la disponibilità dei ricambi (anche per macchine molto datate) e la velocità di fornitura di questi, con attenzione ai costi per il cliente. Crediamo fermamente che sia giusto riparare le macchine piuttosto che buttarle, come dimostra la nostra filosofia del **"PERCHÈ BUTTARE?"**®-Puoi consultare il Regolamento 2021/341 al sito www.bieffeitalia.it

indice

	ITALIANO	ENGLISH	FRANÇAIS	ESPAÑOL	РУССКИЙ
pg. 5	elettroferri	electric irons	fers à repasser électrique	planchas eléctricas	утюги
pg. 13	piastre e calotte	iron plates and iron cases	plaques et calottes	placas y tapas de cubierta de plancha	подшвы и колодки
pg. 17	termostati, termofusibili, microinterruttori, minuteria	thermostats, thermal fuses, microswitches, small hardware/fittings	thermostats, fusibles thermiques, micro-interrupteurs, quincaillerie	termostatos, fusibles térmicos, microinterruptores, erreteria para componentes pequeños	термостаты, термopредохранители, микропереключатели, мелкие детали
pg. 27	cordoni, monotubi, accessori stiro	cords, monotubes and ironing accessories	cordons, tuyau unique et accessoires de repassage	cordones, monotubos accesorios de planchado	кабели электрические, моношланги и аксессуары для глажения
pg. 39	teli e prontotop	covers and prontotop	housse et prontotop	telas y prontotop	ткань, чехлы
pg. 45	caldaie e componenti	boilers and components	chaudières et composants	calderas y componentes	бойлеры и их компоненты
pg. 61	elettrovalvole e manopole	solenoid valves and knobs	électrovannes et boutons	electroválvulas y perillas	электромагнитные клапаны и ручки
pg. 67	pressostati e termostati	pressure switches and boiler thermostat	pressostats et thermostats de chaudière	presostatos y termostatos de caldera	датчики давления термостаты для бойлеров
pg. 73	valvole di sicurezza, tappi e guarnizioni	safety valves, plugs and gaskets	soupapes de sécurité, bouchons et joints	válvulas de seguridad, tapones y juntas	клапаны безопасности, крышки и уплотнения
pg. 79	manometri e rubinetti	pressure gauges, taps and valves	manomètres, robinets et vannes	manómetros, grifos y válvulas	манометры и краны
pg. 85	tubi di ricarica e taniche	refilling hoses, tanks	tubes de remplissage, jerrican	tubos de recarga, tanques	заборные шланги и канистры
pg. 91	pompe, valvole e connessi	pumps, valves and fittings	pompes, robinets et raccords	bombas, válvulas conexiones	насосы, клапаны, фитинги
pg. 97	schede, componenti elettrici e interruttori	electrical boards, components and switches	cartes et composants électriques, interrupteurs	tarjetas eléctricas, componentes eléctricos, interruptores	электронные платы, электрические компоненты, переключатели
pg. 105	cavi di alimentazione	power cables	câbles d'alimentation	cables de alimentación	кабели электропитания
pg. 107	fascette e raccordi	clamps and fittings	colliers de serrage et raccords	bridas y accesorios	хомуты и фитинги
pg. 117	tubi e minuteria	tubes and small parts	tubes et raccords	tubos y accesorios	шланги и мелкие детали
pg. 129	prese e spine vapore	steam sockets and plugs	prises et fiches vapeur	tomas y enchufes de vapor	разъемы и штуцеры
pg. 137	motori, pedaliera, filtri e fusti	motors, pedal assemblies, vacuums, drums and filters	moteurs, pédales, aspirateurs, fûts, filtres	motores, pedales, aspiradores, tambores, filtros	двигатели, педали, аспираторы, баки, фильтры
pg. 145	ruote	wheels	roues	ruedas	колеса
pg. 149	detergenti e nebulizzatori	detergents and nebulizers	détergents et nébuliseurs	detergentes y nebulizadores	моющие средства и распылители
pg. 155	bocchette di aspirazione e vapore	vacuum and steam nozzles	buses d'aspiration et de vapeur	boquillas de aspiración y vapor	аксессуары для подачи пара и аспирации
pg. 165	impugnatura, lance e pistole	handles, lances, and guns	poignées, lances et pistolets	empuñaduras, lanzas y pistolas	шланги, насадки и пистолеты
pg. 185	spazzole e spazzolini	brushes and small brushes	brosses	cepillos	щетки
pg. 195	accessori asciugatura e ozonizzazione	drying and ozonization accessories	accessoires de séchage et d'ozonisation	accesorios de secad y ozonización	аксессуары для сушки и озонирования
pg. 201	ricambi spazzatrici	sweeper spare parts	pièces détachées pour balayeuses	repuestos para barredoras	запасные части для подметальных машин

elettroferri



BIEFFE[®]
FARINELLI
GENERATORI DI VAPORE

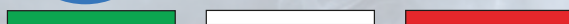

irons

planchas

fers a repasser

утюги

codici

FER1100



elettroferro BIEFFE

1,5 kg

Bieffe Electric Iron

Электропаровой утюг 1,5 кг

Plancha eléctrica Bieffe

Fer à repasser Bieffe



FER1101



elettroferro BIEFFE CAVO 2,5 m

1,5 kg

*BIEFFE Electric Iron
Cable 2,5 m*

Электропаровой утюг с кабелем 250 см

*Plancha eléctrica
BIEFFE Cable 2,5 m*

*Fer à repasser BIEFFE
Câble 2,5 m*



FER1105



elettroferro BIEFFE C/TERM PARAVAP

1,5 kg

*BIEFFE Electric Iron
with Thermal fuse and
handguard*

*Электропаровой утюг с
термопредохран. и
защитой*

*Plancha eléctrica
BIEFFE con fusible
térmico y protector de
mano*

*Fer à repasser BIEFFE
avec fusible thermique
et protection de main*



FER1107



elettroferro BIEFFE 120 V PAR/ TERM

1,5 kg

*BIEFFE Electric
Iron 120V with
Thermal fuse and
handguard*

*Электропаровой утюг 120V с
термопредохран
и защитой*

*Plancha eléctrica
BIEFFE 120V con
fusible térmico y
protector de mano*

*Fer à repasser
BIEFFE 120V avec
fusible thermique et
protection de main*



FER1108

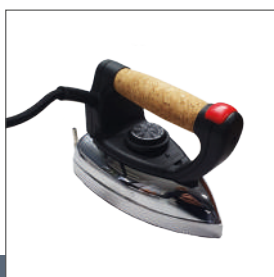

elettroferro BIEFFE tasto centrale

1,5 kg

*BIEFFE Electric Iron with
Central Button*

*Электропаровой утюг 1,5 кг с
центральной
кнопкой*

*Plancha eléctrica
BIEFFE con botón
central*

*Fer à repasser BIEFFE
avec bouton central*



FER1109



elettroferro BIEFFE 1,5 kg TR+PV cavo 2,50 m

1,5 kg

*BIEFFE Electric Iron
1.5KG with Thermal
fuse + handguard +
Cable 2,5 m*

*Электропаровой утюг 1,5 кг 2,5 м с
термопредохран. и
защитой*

*Plancha eléctrica
BIEFFE 1.5KG con fusible
térmico + protector de
mano + Cable 2,5 m*

*Fer à repasser BIEFFE
1,5KG avec fusible
thermique + protection
de main + câble 2,5 m*



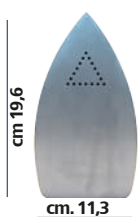

Neutral Electric Iron *Электропаровой утюг нейтральный*
Plancha eléctrica Neutral *Fer à repasser neutre*

elettroferro NEUTRO

1,5 kg



codici

FER1110

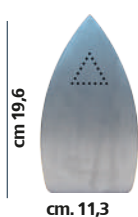

BIEFFE Electric Iron with one only pipe *Электропаровой утюг с моношлангом*
Plancha eléctrica BIEFFE con una sola tubería *Fer à repasser BIEFFE avec un seul tuyau*

elettroferro BIEFFE MONOTUBO

1,5 kg



FER1120

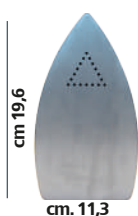

BIEFFE Electric Iron with one only pipe 5 Poles *электропаровой утюг с моношлангом 5-полюсный*
Plancha eléctrica BIEFFE con una sola tubería de 5 polos *Fer à repasser BIEFFE avec un seul tuyau 5 rôles*

elettroferro BIEFFE MONOTUBO 5 poli

1,5 kg



FER1121

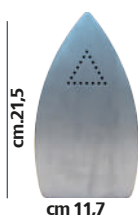

BIEFFE Heavy Electric Iron *Электропаровой утюг "тяжелый"*
Plancha eléctrica BIEFFE Heavy *Fer à repasser BIEFFE lourd*

elettroferro BIEFFE pesante

1,7 kg



FER1200



Plancha eléctrica BIEFFE Heavy Cable 2,5 m *Электропаровой утюг "тяжелый" с кабелем 250 см*
Plancha eléctrica BIEFFE Heavy Cable 2,5 m *Fer à repasser BIEFFE lourd Câble 2,5 m*

elettroferro BIEFFE pesante cavo 2,5 m

1,7 kg



FER1201



BIEFFE Heavy Electric Iron with Thermal fuse + handguard *Электропаровой утюг "тяжелый" с термозащитой и защитой*
Plancha eléctrica BIEFFE Heavy con fusible térmico + protector de mano *Fer à repasser BIEFFE lourd avec fusible thermique + protection de main*

elettroferro BIEFFE pesante TERM+PV

1,7 kg



FER1205

codici

FER1207



elettroferro BIEFFE presa T/CENTR

1,7 kg

BIEFFE Electric
Iron Heavy with
Central Button

Plancha eléctrica
BIEFFE Heavy con
botón central

Электропаровой
утюг "тяжелый"
с центральной
кнопкой

Fer à repasser
BIEFFE lourd avec
bouton central



FER1209



elettroferro BIEFFE pes. TR+PV CAVO 2,5 m

1,7 kg

BIEFFE Heavy Electric
Iron with Thermal fuse
+ handguard + Cable
2,5 m

Plancha eléctrica
BIEFFE Heavy con
fusible térmico +
protector de mano +
Cable 2,5 m

Электропаровой
утюг "тяжелый" 2,5
м с термopредохран
и защитой

Fer à repasser
BIEFFE lourd avec
fusible thermique +
protection de main +
câble 2,5 m



FER1210



elettroferro BIEFFE NEUTRO pesante

1,7 kg

Heavy Neutral
Electric Iron

Plancha eléctrica
Heavy Neutral

Электропаровой
утюг
нейтральный
"тяжелый"

Fer à repasser
neutre lourd



FER1225



elettroferro BIEFFE pesante MONOTUBO

1,7 kg

BIEFFE Heavy
Electric Iron
Thermal fuse

Plancha eléctrica
BIEFFE Heavy
fusible térmico

Электропаровой
утюг
"тяжелый" с
термopредохран

Fer à repasser
BIEFFE lourd
fusible thermique



FER1251



elettroferro BIEFFE pesante A SECCO

1,7 kg

Dry "Heavy" Bieffe
Electric Iron

Plancha eléctrica
"Heavy" Bieffe
seca

Утюг
электрический
"тяжелый" для
сухой глажки

Fer à repasser
"lourd" Bieffe à
sec



FER2101



elettroferro BIEFFE TULIPANO

1,35 kg

Tulipano Electric
Iron

Plancha eléctrica
Tulipano

Электропаровой
утюг Tulipano

Fer à repasser
Tulipano





TULIPANO *Электронпаровой*
Electric Iron *утюг Tulipano*
 "OPEN" "OPEN"
Plancha eléctrica *Fer à repasser*
TULIPANO **TULIPANO**
 "OPEN" "OPEN"

elettroferro
BIEFFE
TULIPANO
open
 1,4 kg



codici

FER2102



TULIPANO *Электронпаровой*
Electric Iron with *утюг Tulipano с*
Steam guard *защитой*
Plancha eléctrica *Fer à repasser*
TULIPANO con **TULIPANO avec**
protector de vapor *protection vapeur*

elettroferro
TULIPANO
C/PARAV
 1,35 kg



FER2103



Tulipano one only *Электронпаровой*
pipe Electric Iron *утюг Tulipano с*
моношлангом
Plancha eléctrica *Fer à repasser*
Tulipano con una **Tulipano avec un**
sola tubería *seul tuyau*

elettroferro
TULIPANO
MONOTUBO
 1,35 kg



FER2104



JOLLY Electric Iron *Утюг*
Plancha eléctrica *электрический*
JOLLY **JOLLY**
Fer à repasser
JOLLY **JOLLY**

elettroferro
JOLLY
 1,7 kg



FER2121

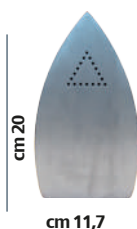

JOLLY Dry Electric *Утюг*
Iron *электрический*
Plancha eléctrica *JOLLY для сухой*
JOLLY seca **JOLLY à sec**
Fer à repasser

elettroferro
JOLLY
SECCO
 1,85 kg



FER1222

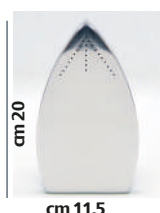

BIRON MASTER *Утюг*
Electric Iron *электрический*
IRON MASTER **IRON MASTER**
Plancha eléctrica *Fer à repasser*
IRON MASTER **IRON MASTER**

elettroferro
IRON
MASTER
 2,2 kg



FER2202

codici

FER2203



elettroferro IRON MASTER

IRON MASTER
Electric Iron

Утюг
электрический
IRON MASTER

Plancha eléctrica
IRON MASTER

Fer à repasser
IRON MASTER

3 kg



FER2204



elettroferro IRON MASTER

IRON MASTER
Electric Iron

Утюг
электрический
IRON MASTER

Plancha eléctrica
IRON MASTER

Fer à repasser
IRON MASTER

1,5 kg

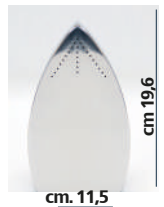

FER2221



elettroferro MASCHIO

Maschio Electric
Iron

Утюг
электрический
Maschio

Plancha eléctrica
Maschio

Fer à repasser
Maschio

1,65 kg

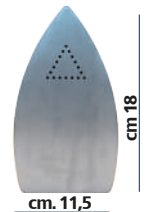

FER2251



elettroferro ALL STEAM SOLO VAPORE

ALL STEAM
Electric Iron

Электропаровой
утюг ALL STEAM

Plancha eléctrica
ALL STEAM

Fer à repasser ALL
STEAM

1,3 kg

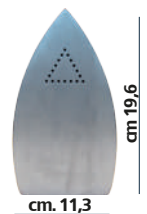

FER2261



elettroferro APRIPIEGA 600 W

Apripiega Electric
Iron 600W

Утюг для
расколки швов
600W

Plancha eléctrica
Apripiega 600W

Fer à repasser
Apripiega 600W

1,3 kg

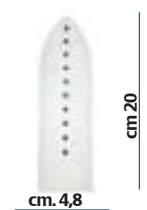

K1MG



elettroferro professionale MAGIC VAPOR EASY VAPOR

Professional
Electric Iron Magic
Vapor/Easy Vapor

Электропаровой
утюг профес.
Magic Vapor/Easy
Vapor

Plancha eléctrica
profesional Magic
Vapor/Easy Vapor

Fer à repasser
professionnel
Magic Vapor /
Easy Vapor

1,5 kg

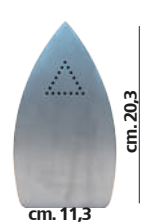

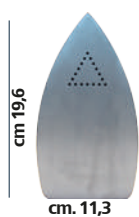

*Magic Vapor
Ra/Steam Iron
Connection
Electric Iron*

*Электронпаровой
утюг для Magic
Vapor Ra/Steam
Iron*

*Plancha eléctrica
Magic Vapor
Ra/Steam Iron
Connection*

*Fer à repasser
Magic Vapor
Ra / Steam Iron
Connection*

**elettroferro
collegamento
Magic Vapor
Ra/Steam
Iron**
1,4 kg



codici

K1MG2

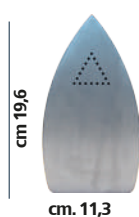

*FL1 + Steam
hose + ILME Plug
Electric Iron*

*Электронпаровой
утюг FL1+Паровой
шланг+Вилка
ILME*

*Plancha eléctrica
FL1 + Tubo de
vapor + Enchufe
ILME*

*Fer à repasser FL1
+ Tuyau vapeur +
Prise ILME*

**elettroferro
FL1
TUBO vapore
SPINA ILME**
1,5 kg



KITF001

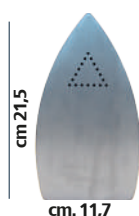

*FP1 ILME Plug
Electric Iron*

*Электронпаровой
утюг FP1 Вилка
ILME*

*Plancha eléctrica
FP1 Enchufe ILME*

*Fer à repasser FP1
Prise ILME*

**elettroferro
FP1
SPINA ILME**
1,7 kg



KITF002

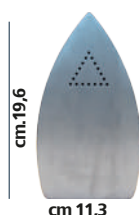

*FN1 + Steam
hose + ILME Plug
Electric Iron*

*Электронпаровой
утюг
FN1+Паровой
шланг+Вилка ILME*

*Plancha eléctrica
FN1 + Tubo de
vapor + Enchufe
ILME*

*Fer à repasser FN1
+ Tuyau vapeur +
Prise ILME*

**elettroferro
FN1
TUBO vapore
SPINA ILME**
1,5 kg



KITF003

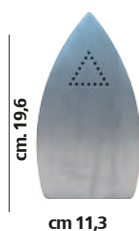

*Bieffe FN1 +
Braided steam
hose*

*Электронпаровой
утюг
FN1+Паровой
шланг*

*Plancha eléctrica
Bieffe FN1 +
Trenza de tubo de
vapor*

*Fer à repasser
Bieffe FN1 + Tuyau
vapeur tressé*

**elettroferro
FN1
TUBO vapore
TRECCIA**
1,5 kg



KITF0041

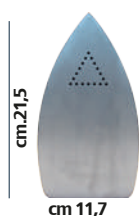

*Bieffe LARGE +
Braided steam
hose*

*Электронпаровой
утюг GRANDE +
Паровой шланг в
оплетке*

*Plancha eléctrica
Bieffe LARGE +
Trenza de tubo de
vapor*

*Fer à repasser
Bieffe LARGE +
Tuyau vapeur
tressé*

**elettroferro
BIEFFE grande
TUBO vapore
TRECCIA**
1,7 kg



KITF0042

codici

KITF043



elettroferro TULIPANO con tubo vapore TRECCIA

1,5 kg

*Tulipano FL1
1.35Kg + Braided
steam hose*

*Plancha eléctrica
Tulipano FL1
1.35Kg + Trenza de
tubo de vapor*

*Электронпаровой
утюг Tulipano FL1
1,35 кг + Паровой
шланг в оплетке
Fer à repasser
Tulipano FL1
1,35Kg + Tuyau
vapeur tressé*



piastre
calotte



Iron plates
ironcases

placas y tapas de
cubierta de plancha

plaques et
calottes

ПОДОШВЫ И
КОЛОДКИ

codici

AR5



**piastra ferro
TULIPANO**

Tulipano Iron Plate

*Подошва утюга
Tulipano*

*Placa de la plancha
Tulipano*

Plaque en fer Tulipano

AR5C

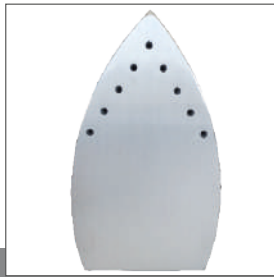

**piastra ferro
TULIPANO
uscita calotta**

*Tulipano Iron Plate -
Cap Outlet*

*Подошва утюга
Tulipano - выход из
колодки*

*Placa de la plancha
Tulipano - Salida de
tapón*

*Plaque en fer Tulipano
- Sortie du capot*

AR5M

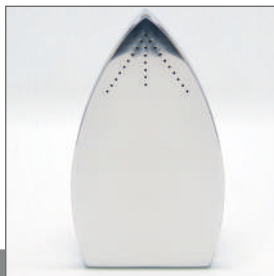

**piastra ferro
MASCHIO**

Maschio Iron Plate

*Подошва утюга
Maschio*

*Placa de la plancha
Macho*

Plaque en fer Maschio

AR5N

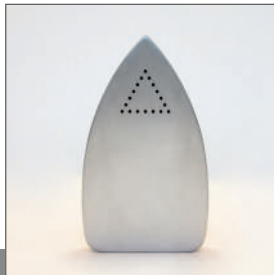

**piastra ferro
BIEFFE**

Bieffe Iron Plate

*Подошва утюга
Bieffe*

*Placa de la plancha
Bieffe*

Plaque en fer Bieffe

AR5NA

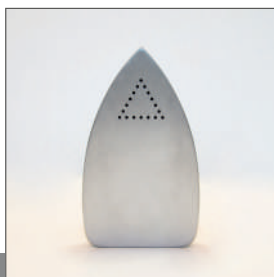

**piastra ferro
BIEFFE
110/120V**

*Bieffe Iron Plate 110-
120V*

*Подошва утюга
Bieffe 110-120V*

*Placa de la plancha
Bieffe 110-120V*

*Plaque en fer Bieffe
110-120V*

AR5NS



**piastra ferro
a secco BIEFFE**

Bieffe Dry Iron Plate

*Подошва утюга
Bieffe для сухой
глажки*

*Placa de la plancha
Bieffe seca*

*Plaque en fer Bieffe
à sec*

Bieffe "Heavy" Iron Plate

Подошва утюга Bieffe "тяжелый"

piastra ferro BIEFFE PROFESSIONALE PESANTE



codici

AR5P

Placa de la plancha Bieffe "Heavy"

Plaque en fer Bieffe "lourde"

Iron Master Iron Plate

Подошва утюга Iron Master

piastra ferro IRON MASTER

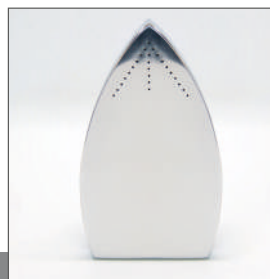

AR5I

Placa de la plancha Iron Master

Plaque en fer Iron Master

Apripiega Iron Plate

Подошва утюга apripiega

piastra ferro APRIPIEGA



AR5AP

Placa de la plancha Apripiega

Plaque en fer Apripiega

Professional Bieffe Iron Cover Cap

Колодка для утюга Bieffe "тяжелый"

piastra ferro BIEFFE PESANTE



AR73

Tapa de cubierta de plancha profesional Bieffe

Couvercle en fer Bieffe professionnel

Bieffe Iron cover Cap

Колодка для утюга Bieffe

calotta ferro da stiro BIEFFE piccolo



AR160

Tapa de cubierta de plancha Bieffe

Couvercle en fer Bieffe

Tulipano Iron cover Cap

Колодка для утюга Tulipano

calotta ferro TULIPANO



AR65

Tapa de cubierta de plancha Tulipano

Tulipano Iron cover Cap

codici

**termostati
termofusibili
microinterruttori
minuteria**



**thermostats
thermal fuses
microswitches
small hardware / fittings**

**termostatos
fusibles termicos
microinterruptores
ferreteria para componentes pequenos**

**thermostats
fusibles thermiques
micro-interrupteurs
quincaillerie (pour petites pieces)**

**термостаты
термопредохранители
микрореле
мелкие детали**

codici

AR170



**manopola
regolazione
termostato
BIEFFE con
paravapore**

*Adjustable thermostat
knob for Bieffe Iron
with Steam Guard*

*Ручка термостата
для утюга Bieffe с
защитой*

*Perilla de termostato
ajustable para plancha
Bieffe con protector de
vapor*

*Bouton de réglage du
thermostat pour fer à
repasser Bieffe avec
protection vapeur*

AR33



**manopola
regolazione
termostato
TULIPANO**

*Tulip adjustable
thermostat knob*

*Ручка термостата
для утюга Tulipano*

*Perilla de termostato
ajustable para plancha
Tulipano*

*Bouton de réglage du
thermostat Tulipano*

AR35



**manopola
regolazione
termostato
BIEFFE**

*Bieffe adjustable
thermostat knob*

*Ручка термостата
для утюга Bieffe*

*Perilla de termostato
ajustable para plancha
Bieffe*

*Bouton de réglage du
thermostat Bieffe*

AR12

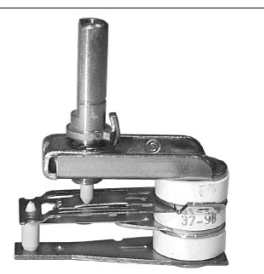

**termostato
ferro
BIEFFE**

Bieffe Iron Thermostat

*Термостат для
утюга Bieffe*

*Termostato de plancha
Bieffe*

*Thermostat pour fer
Bieffe*

AR12I



**termostato
ferro
IRON MASTER**

*Iron Master Iron
Thermostat*

*Термостат для
утюга Iron Master*

*Termostato de plancha
Iron Master*

*Thermostat pour fer
Iron Master*

AR12M



**termostato
integrato
MASCHIO /
JOLLY**

*Male/Jolly Integrated
Thermostat*

*Интегрированный
термостат для
утюгов Maschio/Jolly*

*Termostato integrado
de Male/Jolly*

*Thermostat intégré
pour Maschio/Jolly*

Tulip Iron Thermostat

Термостат для утюга Tulipano

termostato ferro TULIPANO



codici

Termostato de plancha Tulipano

Thermostat pour fer Tulipano

AR30

Tulip Iron Thermostat with Fuse

Термостат для утюга Tulipano с предохранителем

termostato ferro TULIPANO con fusibile interno

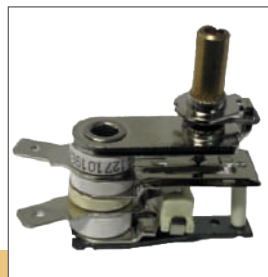

Termostato de plancha Tulipano con fusible

Thermostat pour fer Tulipano avec fusible intégré

AR30I

30/90° Thermostat with Complete Adjustment

Термостат 30/90° с регулировкой в сборе

termostato 30°/90° con regolazione completa

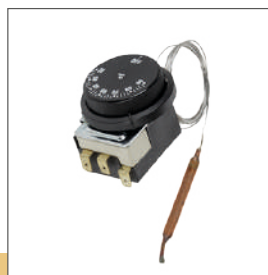

Termostato de 30/90° con ajuste completo

Thermostat 30/90° avec réglage complet

TS10

Tulip Male Micro Iron

Микропереключатель для утюга Tulipano Maschio

micro ferro TULIPANO maschio

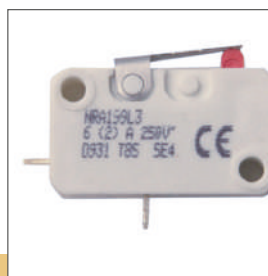

Microplancha Tulipano Male

Micro pour fer Tulipano Maschio

AR4

TERMOSTATI CERAMICI E SPECIALI A RIARMO AUTOMATICO/MANUALE

SU ORDINAZIONE



B7D



B7AD

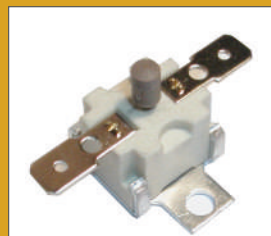

B75E



B15V

codici

AR4P



microinterruttore completo per ferro BIEFFE

Complete Micro Switch for Bieffe Iron

Микропереключатель в сборе для утюга Bieffe

Interruptor micro completo para plancha Bieffe

Interrupteur complet pour fer Bieffe

AR95



microinterruttore completo per ferro IRON MASTER

Complete Micro Switch for Iron Master Iron

Микропереключатель в сборе для утюга IRON MASTER

Interruptor micro completo para plancha Iron Master

Interrupteur complet pour fer Iron Master

AR4C



microinterruttore centrale con cavetti

Central Micro Switch with Cables

Центральный микропереключатель с проводами

Interruptor micro central con cables

Interrupteur central avec câbles

AR90

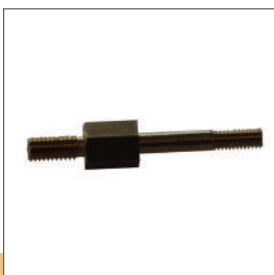

colonna alta termostato TULIPANO

Tulip High Thermostat Column

Высокий стержень термостата для утюга Tulipano

Column de termostato alto Tulipano

Colonne haute pour thermostat Tulipano

AR90/1



colonna alta termostato integrato TULIPANO

Integrated Tulip High Thermostat Column

Интегрированный высокий стержень термостата для утюга Tulipano

Column de termostato alto integrado de Tulipano

Colonne haute pour thermostat intégré Tulipano

AR72S



morsettiera ferro BIEFFE senza cavetti

Bieffe Iron Terminal Block without Cables

Клеммный блок для утюга Bieffe без кабелей

Bloque de terminales de plancha Bieffe sin cables

Bornier pour fer Bieffe sans câbles

Bieffe Iron Cable Terminal with Thermal Fuse Клеммный блок для кабеля утюга Bieffe с предохранителем

Bloque de terminales de plancha Bieffe con fusible térmico Bornier pour câbles de fer Bieffe avec fusible thermique

morsettiera cab. ferro BIEFFE con termofusibile

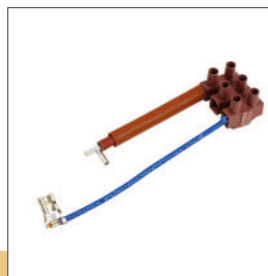

codici

AR72

Mammut 12 pole 1.5 Клеммная колодка Mammut 12 контактов 1,5

Mammut 12 polos 1.5 Connecteur 12 pôles 1,5 Mammut

mammut 12 poli 1,5



C213

Tulip Iron Micro Cover Box Коробка-крышка для микропереключателя утюга Tulipano

Caja de cubierta micro de plancha Tulipano Boîtier de protection micro pour fer Tulipano

scatola copri microferro TULIPANO



AR4CM

Tulip Iron 1/4 Filter Cap Пробка фильтра 1/4 для утюга Tulipano

Tapa de filtro 1/4 de plancha Tulipano Bouchon de filtres 1/4 pour fer Tulipano

tappo filtro 1/4 ferro TULIPANO



AR37

Bieffe Iron Micro Cover Box Коробка-крышка для микропереключателя утюга Bieffe

Caja de cubierta micro de plancha Bieffe Boîtier de protection micro pour fer Bieffe

scatola copri microferro BIEFFE



AR74

Bieffe/Brook Iron Steam Connection L 1/8 Паровой разъем для утюга Bieffe/Brook L 1/8

Conexión de vapor Bieffe/Brook L 1/8 Raccord vapeur L 1/8 pour fer Bieffe/Brook

raccordo vapore ferro BIEFFE / BROOK L 1/8



R801

codici

C31



**raccordo
vapore ferro
TULIPANO I 1/4**

*Tulip Iron Steam
Connection L 1/4*

*Паровой разъем для
утюга Tulipano L 1/4*

*Conexión de vapor
Tulipano L 1/4*

*Raccord vapeur L 1/4
pour fer Tulipano*

AR63



**manico
completo IRON
MASTER**

*IRON MASTER
Complete Handle*

*Ручка в сборе для
утюга IRON MASTER*

*Mango completo de
IRON MASTER*

*Poignée complète
pour fer Iron Master*

AR56



**manico in
sughero ferro
TULIPANO**

*Cork Handle for Tulip
Iron*

*Пробковая ручка для
утюга Tulipano*

*Mango de corcho
para plancha Tulipano*

*Poignée en liège pour
fer Tulipano*

AR57



**nocciolo
anteriore
TULIPANO**

Tulip Front Core

*Передний
держатель для
утюга Tulipano*

*Núcleo frontal de
Tulipano*

*Noyau antérieur pour
fer Tulipano*

AR61

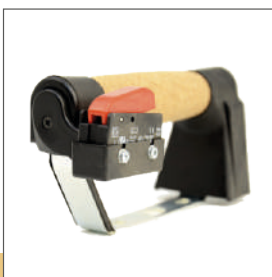

**manico in
sughero
completo ferro
BIEFFE**

*Complete Cork
Handle for Bieffe Iron*

*Пробковая ручка для
утюга Bieffe*

*Mango completo de
corcho para plancha
Bieffe*

*Poignée en liège
complète pour fer
Bieffe*

AR59



**coperchio
posteriore ferro
BIEFFE**

Bieffe Iron Rear Cover

*Задняя крышка для
утюга Bieffe*

*Cubierta trasera de
plancha Bieffe*

*Couvercle postérieure
pour fer Bieffe*

*Black Steam Guard
for Bieffe Iron* *Черная защитная
накладка для утюга
Bieffe*

*Protector de vapor
negro para plancha
Bieffe* *Paravapeur noir pour
fer Bieffe*

paravapore nero ferro BIEFFE



codici

AR14

*Blue Steam Guard for
Tulip Iron* *Синяя защитная
накладка для утюга
Tulipano*

*Protector de vapor
azul para plancha
Tulipano* *Paravapeur bleu pour
fer Tulipano*

paravapore blu ferro TULIPANO



AR20

Tulip Iron Mask *Накладка-этикетка
для утюга Tulipano*

*Máscara de plancha
Tulipano* *Masque pour fer
Tulipano*

mascherina ferro TULIPANO

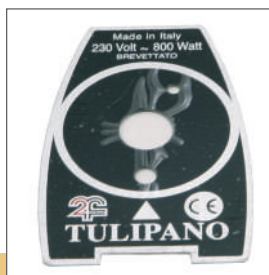

AR60

Bieffe Iron Mask *Накладка-этикетка
для утюга Bieffe*

*Máscara de plancha
Bieffe* *Masque pour fer Bieffe*

mascherina ferro BIEFFE



AR62

*IRON MASTER Iron
Mask* *Накладка-этикетка
для утюга IRON
MASTER*

*Máscara de plancha
IRON MASTER* *Masque pour fer Iron
Master*

mascherina ferro IRON MASTER



AR66

Tulip Iron Filter *Фильтр для утюга
Tulipano*

*Filtro de plancha
Tulipano* *Filtre pour fer Tulipano*

filtro ferro TULIPANO



AR1

codici

AR75



**supporto porta
microferro
BIEFFE**

*Bieffe Iron Micro
Support Holder*

*Фильтр для утюга
Tulipano*

*Soporte de sujeción
micro de plancha
Bieffe*

*Support pour micro de
fer Bieffe*

AR151

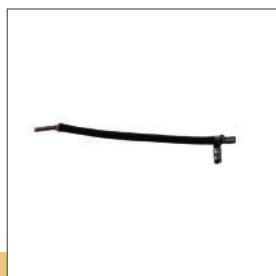

**cavetto
resistenza
termostato
0,5x108 mm**

*Thermostat Resistance
Cable 0,5x108 mm*

*Кабель для
термостата
0,5x108 mm*

*Cable de resistencia del
termostato
0,5x108 mm*

*Câble de résistance
pour thermostat
0,5x108 mm*

AR167



**cavetto
morsettiera
/ termostato
BIEFFE**

*Bieffe Terminal Block/
Thermostat Cable*

*Кабель для
клеммного блока/
термостата Bieffe*

*Cable de bloque de
terminales/termostato
Bieffe*

*Câble pour bornier/
thermostat Bieffe*

AR79A

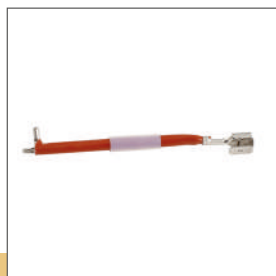

**termofusibile
ferro TULIPANO
pick-back con
spia**

*Tulip Iron Pick-back
Thermal Fuse with
Indicator*

*Термопредохранитель
для утюга Tulipano с
индикатором*

*Fusible térmico de
retorno de plancha
Tulipano con indicador*

*Fusible thermique
pour fer Tulipano avec
témoin lumineux*

AR79B



**termofusibile
ferro TULIPANO
con occhio**

*Tulip Iron Thermal Fuse
with Eyelet*

*Термопредохранитель
для утюга Tulipano с
отверстием*

*Fusible térmico de
plancha Tulipano con
ojal*

*Fusible thermique pour
fer Tulipano avec œillet*

AR119



**termofusibile
ferro BROOK
apripiega 305 °**

*BROOK Iron 305°
Apripiega Thermal
Fuse*

*Термопредохранитель
для утюга BROOK
apripiega 305°*

*Fusible térmico de
plancha BROOK 305°
Apripiega*

*Fusible thermique pour
fer Brook apripiega
305°*

Tulip Iron 1990
Thermal Fuse

Термопредохранитель
для утюга Tulipano 1990

termofusibile
ferro TULIPANO
1990

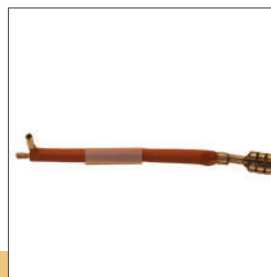

codici

AR79

Fusible térmico de
plancha Tulipano
1990

Fusible thermique
pour fer Tulipano 1990

Bieffe Iron Thermal
Fuse

Термопредохранитель
для утюга Bieffe

termofusibile
ferro BIEFFE



AR80

Fusible térmico de
plancha Bieffe

Fusible thermique
pour fer Bieffe

Mica Resistance for
800W Iron

Нагревательный
элемент из слюды
для утюга 800W

resistenza in
mica per ferro
800 W



AR6

Resistencia de mica
para plancha de
800W

Résistance en mica
pour fer 800W

Tulip Iron Micro Cover
Cap

Защита для
микрореле утюга Tulipano

cuffia copri
microferro
TULIPANO



AR54

Tapa de cubierta
micro de plancha
Tulipano

Couvre-micro pour fer
Tulipano

Bieffe Iron Cable
Grommet

Держатель кабеля
для утюга Bieffe

passacavo ferro
BIEFFE



AR69

Arandela de cable de
plancha Bieffe

Passage de câble pour
fer Bieffe

Tulip Iron Cable
Grommet

Держатель кабеля
для утюга Tulipano

passacavo ferro
TULIPANO



AR55

Arandela de cable de
plancha Tulipano

Passage de câble pour
fer Tulipano

codici

AR45P



**passacavo
ferro BIEFFE
monotubo**

*Bieffe Monotube Iron
Cable Grommet*

*Держатель кабеля
для утюга Bieffe с
моношлангом*

*Arandela de cable de
plancha monotubo
Bieffe*

*Passage de câble pour
fer Bieffe Monotube*

AR45T



**passacavo ferro
TULIPANO
monotubo**

*Tulip Monotube Iron
Cable Grommet*

*Держатель кабеля
для утюга Tulipano с
моношлангом*

*Arandela de cable de
plancha monotubo
Tulipano*

*Passage de câble pour
fer Monotube Tulipano*

AR58



**coperchio
posteriore
TULIPANO**

Tulip Rear Cover

*Задняя крышка
утюга Tulipano*

*Cubierta trasera de
plancha Tulipano*

*Couvercle postérieure
pour fer Tulipano*

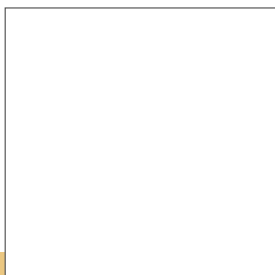
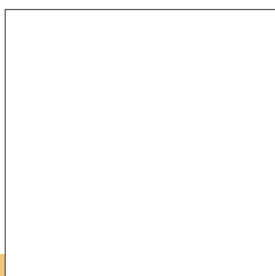

**cordoni
monotubi
accessori stiro**



**CORDS, MONOTUBES,
IRONING ACCESSORIES**

**CORDONES, MONOTUBOS
ACCESORIOS DE PLANCHADO**

**CORDONS, TUYAU UNIQUE
ACCESSOIRES DE REPASSAGE**

**КАБЕЛИ ЭЛЕКТРИЧЕСКИЕ,
МОНОШЛАНГИ И АКСЕССУАРЫ
ДЛЯ
ГЛАЖЕНИЯ**

codici

C17C



cordone elettrico ferro completo 4x1 cm 2 m

Complete Electric Cord for Iron 4x1 cm 2 m

Кабель электрический для утюга 4x1 2м

Cable eléctrico completo para plancha 4x1 cm 2 m

Cordon électrique complet pour fer 4x1 cm 2 m

C28



monotubo nero 4x0,75 cm C/Faston 2 m

Black Monotube 4x0,75 cm C/Faston 2 m

Черный монокабель 4x0,75 2м

Monotubo negro 4x0,75 cm C/Faston 2 m

Monotube noir 4x0,75 cm avec Faston 2 m

C17



cordone elettrico ferro 4x0,75 cm 50 m

Electric Cord for Iron 4x0,75 cm 50 m

Кабель электрический для утюга 4x0,75 50 м

Cable eléctrico para plancha 4x0,75 cm 50 m

Cordon électrique pour fer 4x0,75 cm 50 m

C28A



monotubo 5 poli C/Faston 2 m

5-Pole Monotube C/Faston 2 m

5-полюсный монокабель 2 м

Monotubo de 5 polos C/Faston 2 m

Monotube 5 pôles avec Faston 2 m

AR81



bilanciatore snodato

Articulated Balancer

Балансир для утюга

Equilibrador articulado

Équilibrage articulé

AR132



pistola smacchiatrice a due entrate

2-Entry Stain Removing Gun

Пистолет-удалитель пятен с двумя входами

Pistola de eliminación de manchas con 2 entradas

Pistolet détachant à 2 entrées

Electro Iron Pulley
1-2 kg

Шкив для
электроутюга
1-2 кг

**carrucola
elettroferro
1 - 2 kg**



codici

RIS0502

Polea eléctrica para
plancha de 1-2 kg

Poulie pour fer
électrique 1-2 kg

Red Silicone Iron Rest
Pad

Коврик красный
силиконовый для
утюга

**pedanina
appoggiaferro
silicone rossa**



C21S

Almohadilla de
descanso de silicona
roja para plancha

Repose-fer en silicone
rouge

Black Silicone Iron
Rest Pad

Коврик черный
силиконовый для
утюга

**pedanina
appoggiaferro
silicone nera**



C21

Almohadilla de
descanso de silicona
negra para plancha

Repose-fer en silicone
noir

Armored Teflon
Soleplate for Iron
Master

Накладка
тефлоновая
металлизированная
для утюга Iron Master

**soletta teflon
corazzata IRON
MASTER**

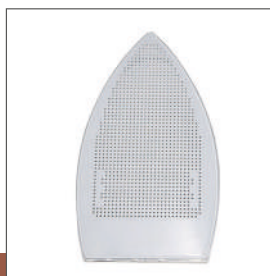

AR81

Suela de teflón
blindada para Iron
Master

Semelle en Téflon
blindée pour Iron
Master

Armored Teflon
Soleplate for Male
Iron

Накладка
тефлоновая
металлизированная
для утюга Maschio

**soletta teflon
corazzata
MASCHIO**



AR8M

Suela de teflón
blindada para
plancha Male

Semelle en Téflon
blindée pour fer
Maschio

Armored Teflon
Soleplate for Tulip
Iron

Накладка
тефлоновая
металлизированная
для утюга Tulipano

**soletta teflon
corazzata
TULIPANO**



AR8T

Suela de teflón
blindada para
plancha Tulip

Semelle en Téflon
blindée pour fer
Tulipano

codici

AR8A



**soletta teflon
corazzata
APRIPIEGA**

*Armored Teflon
Soleplate for
Apripiega*

*Накладка тефлоновая
металлизированная
для утюга Apripiega*

*Suela de teflón
blindada para
plancha Apripiega*

*Semelle en Teflon
blindée pour fer
Apripiega*

AR8B



**soletta teflon
corazzata ferro
BROOK**

*Armored Teflon
Soleplate for BROOK
Iron*

*Накладка
тефлоновая
металлизированная
для утюга BROOK*

*Suela de teflón
blindada para
plancha BROOK*

*Semelle en Teflon
blindée pour fer
BROOK*

AR8



**soletta teflon
semplice ferro
BIEFFE 1,5 kg**

*Simple Teflon
Soleplate for Bieffe
Iron 1.5 kg*

*Простая
тефлоновая
накладка для утюга
Bieffe 1,5 кг*

*Suela de teflón simple
para plancha Bieffe
1.5 kg*

*Semelle en Teflon
simple pour fer Bieffe
1,5 kg*

AR8G



**soletta teflon
semplice
ferro BIEFFE
professionale
1,7 kg**

*Professional Teflon
Soleplate for Bieffe
Iron 1.7 kg*

*Простая тефлоновая
накладка для
профессионального
утюга Bieffe 1,7 кг*

*Suela de teflón
profesional para
plancha Bieffe 1.7 kg*

*Semelle en Teflon
simple pour fer Bieffe
professionnel 1,7 kg*

AR8S



**soletta teflon
bordata ferro
BIEFFE 1,5 kg**

*Bordered Teflon
Soleplate for Bieffe
Iron 1.5 kg*

*Накладка тефлоновая
с бортами для утюга
Bieffe 1,5 кг*

*Suela de teflón con
borde para plancha
Bieffe 1.5 kg*

*Semelle en Teflon
bordée pour fer Bieffe
1,5 kg*

AR8V



**soletta teflon
bordata
ferro BIEFFE
professionale
1,7 kg**

*Bordered Teflon
Soleplate for Bieffe
Professional Iron 1.7*

*Накладка тефлоновая
с бортами для
профессионального
утюга Bieffe 1,7 кг*

*Suela de teflón con
borde para plancha
profesional Bieffe 1.7
kg*

*Semelle en Teflon
bordée pour fer Bieffe
professionnel 1,7 kg*

codici

AR8P

AR8C

RIS3232

AR29

AR9

AR86

31

Armored Teflon
Soleplate for Bieffe
Iron 1.5 kg

Накладка
тефлоновая
металлизирующая
для утюга Bieffe 1,5 кг

**soletta teflon
corazzata ferro
BIEFFE 1,5 kg**

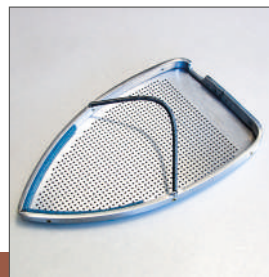

Suela de teflón
blindada para
plancha Bieffe 1.5 kg

Semelle en Téfalon
blindée pour fer Bieffe
1,5 kg

Armored Teflon
Soleplate for Bieffe
Professional Iron
1.7 kg

Накладка тефлоновая
металлизирующая
для профессионального
утюга Bieffe 1,7 кг

**soletta teflon
corazzata
ferro BIEFFE
professionale
1,7 kg**

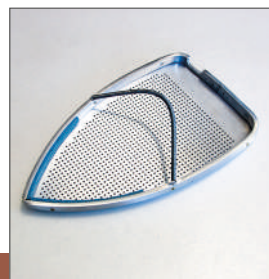

Suela de teflón
blindada para
plancha profesional
Bieffe 1.7 kg

Semelle en Téfalon
blindée pour fer Bieffe
professionnel 1,7 kg

Universal Armored
Teflon Soleplate

Накладка
тефлоновая
металлизирующая
универсальная

**soletta teflon
corazzata
universale
per ferri non
Bieffe**



Suela de teflón
universal blindada

Semelle en Téfalon
blindée universelle

Iron Cleaning Paste

Паста для чистки
утюга

pasta puliferro



Pasta de limpieza
para plancha

Pâte nettoyante
pour fer

AR29

Iron Cleaning Stick

Карандаш для
чистки утюга

stick puliferro



Barra de limpieza
para plancha

Bâton de nettoyage
pour fer

AR9

Iron Cleaning Felt

Фетровая салфетка
для чистки утюга

feltro puliferro



Fieltro de limpieza
para plancha

Feutre de nettoyage
pour fer

AR86

codici

AR134



tappeto stiro velluto
700x300 mm

Velvet Ironing Carpet
- Size: 700x300mm

Коврик для глажения
велюра, размером
700x300 мм

Alfombra de
planchado de
terciopelo - Tamaño:
700x300mm

Tapis de repassage en
velours - dim. 700x300
mm

RIS3055



**sacco antiurto
in rete per
lavasecco per
biancheria**
Ø 20x20 cm

laundry net bag for
dry cleaning for linen
d.20 x h 20 cm

етчатый мешок для
стирки белья d.20 x
h 20 cm

bolsa de rejilla para
lavandería en seco para
ropa d.20 x h 20 cm

sac filet antichoc pour
le nettoyage à sec pour
le linge d.20 x h 20 cm

COF2061



**coperchio
forato tavolo
da stiro**
12/10

Perforated Ironing
Board Cover

Перфорированная
крышка для
гладильного стола

Funda para tabla de
planchar perforada

Couvercle perforé pour
table à repasser

KITF105



**kit spazzola
FACILE PLUS con
spina ILME**

Easy Plus Brush Kit
with ILME Plug

Щетка FACILE
PLUS в комплекте с
разъемом ILME

Kit de cepillo Easy
Plus con enchufe
ILME

Kit brosse "facile plus"
avec prise ILME

KITAV06



**kit spazzola
SPEEDY con spina
ILME**

SPEEDY Brush Kit
with ILME Plug

Щетка SPEEDY
в комплекте с
разъемом ILME

Kit de cepillo SPEEDY
con enchufe ILME

Kit brosse SPEEDY
avec prise ILME

RIS1101



**telaio setole
spazzola vapore
SACRPAVAPOR
modello
precedente**

Previous Model
SCARPAVAPOR
steam Brush Silicone
Bristle Frame
Marco de cerdas
para cepillo de vapor
SCARPAVAPOR

Вкладыш с щетинами
для паровой щетки
SCARPAVAPOR,
модель предыдущая
Cadre en soies
pour brosse vapeur
SCARPAVAPOR

Kit "speedy" steam
brush w/Magic
connection

Паровая щетка
"SPEEDY" с
разъемом Magic

Kit cepillo "speedy"
con enchufe de vapor

Kit brosse vapeur
"speedy" a/connection
Magic

**kit spazzola
vapore SPEEDY
con spina vapore**



codici

KITMG03

Tulip Iron 1990
Thermal Fuse

Термопредохранитель
для утюга Tulipano I
990

Fusible térmico de
plancha Tulipano
1990

Fusible thermique
pour fer Tulipano 1990

**Kit spazzola
FACILE STIRO
vapore riscaldata
c/spina vapore**



KITF104

Bieffe Iron Thermal
Fuse

Термопредохранитель
для утюга Bieffe

Fusible térmico de
plancha Bieffe

Fusible thermique
pour fer Bieffe

**Kit spazzola
riscaldata FACILE
PLUS con setole
c/spina vapore**



KITF102

Speedy 500W steam
Brush

Паровая щетка
"speedy" 500 Wm

Cepillo de vapor
"speedy" 500W

Brosse vapeur
"speedy" 500W

**spazzola vapore
SPEEDY 500W**



AR115

Cepillo de vapor H -
SCARPAVAPOR / No
Limits / Plus

Паровая щетка H -
SCARPAVAPOR/No
Limits/Plus

Cepillo de vapor H -
SCARPAVAPOR / No
Limits / Plus

Brosse vapeur H -
SCARPAVAPOR/No
Limits/Plus

**spazzola vapore
H- SCARPAVAPOR
/ NO LIMITS /
PLUS**



RIP0921

Silicone Bristle Frame
for Bieffe steam
Brush

Вкладыш с
силиконовыми
щетинами для
паровой щетки Bieffe

Marco de cerdas de
silicona para cepillo
Bieffe

Cadre en silicone pour
brosse Bieffe

**telaio setole
silicone per
spazzola BIEFFE**



RIS1102

codici

COF2415



asta reggicavo con riccio Ø 6-1 51 cm

Cable Holding Rod with Spiral Ø 6 - Length 51cm

Держатель кабеля с завитком, 51 см Ø 6

Varilla de sujeción de cables con espiral de Ø 6 - Longitud 51 cm

Tige porte-câble avec ressort Ø 6 - L51cm

C13



asta reggicavo 50 cm

Cable Holding Rod - 50cm

Держатель кабеля 50см

Varilla de sujeción de cables - 50 cm

Tige porte-câble 50 cm

C13L



asta reggicavo 65 cm

Cable Holding Rod - 65 cm

Держатель кабеля 65 см

Varilla de sujeción de cables - 65 cm

Tige porte-câble 65 cm

C13R



asta reggicavo con riccio 55 cm

Cable Holding Rod with Spiral - 55 cm

Держатель кабеля с завитком, 55 см

Varilla de sujeción de cables con espiral 55 cm

Tige porte-câble avec ressort 55 cm

COF2416

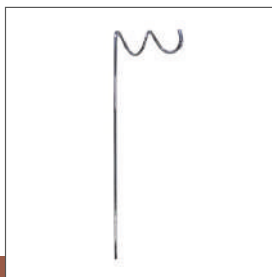

asta reggicavo C/riccio doppio Ø 6x58 cm

Cable Holding Rod with Double Spiral Diameter 6 - Length 58cm

Держатель кабеля с двойным завитком d.6 58см

Varilla de sujeción de cables con doble espiral de diámetro 6 - Longitud 58 cm

Tige porte-câble double avec ressort diam.6 58 cm

CW117

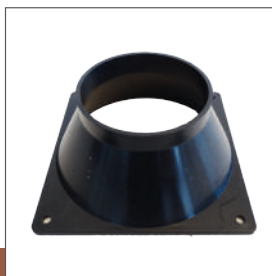

imbuto di plastica Ø 68/120 mm

Plastic Funnel Ø 68/120 mm

Воронка пластиковая Ø 68/120 мм

Embudo de plástico de Ø 68/120 mm

Entonnoir en plastique Ø 68/120 mm

Vacuum Sleeve Arm Рукавная колодка с всасыванием

braccetto aspirante



Brazo aspirante Support aspirant

codici

BF075

Heated Vacuum Sleeve Arm Рукавная колодка с всасыванием и подогревом

braccetto aspirante riscaldato



Fusible térmico de plancha Tulipano con ojal Support aspirant chauffé

BF074

Ironing Sleeve Arm Рукавная колодка

braccetto stiramanche



Brazo para mangas de plancha Support pour manche de repassage

BF011

Steam Generator Cart Тележка для парогенератора

carrello per generatore di vapore



Carro para generador de vapor Chariot pour générateur de vapeur

BF050

Steam Generator Cart - Size: 39x25x74 cm Тележка для парогенератора - размеры 39x25x74

carrello per generatore di vapore dim. 39x25x74 cm



Carro para generador de vapor - Tamaño: 39x25x74 cm Chariot pour générateur de vapeur - dim. 39x25x74 cm

BF007

Cart for MAXI VAPOR/MAXI VAPOR PLUS Тележка для MAXI VAPOR/MAXI VAPOR PLUS

carrello per MAXI VAPOR / MAXI VAPOR PLUS



Carro para modelo MAXI VAPOR/MAXI VAPOR PLUS Chariot pour MAXI VAPOR/MAXI VAPOR PLUS

BF071

codici

BF051



**carrello per
AUTOMATIC
VAPOR PLUS**

*Cart for AUTOMATIC
VAPOR PLUS model*

*Тележка для
АУТОМАТИС VAPOR
PLUS*

*Carro para modelo
AUTOMATIC VAPOR
PLUS*

*Chariot pour modèle
AUTOMATIC VAPOR
PLUS*

BF068B



**raccoglietenda
per FOREVER
rettangolare
150x180 cm**

*Rectangular Curtain
Gatherer for
FOREVER - 150x80cm*

*аксессуар для
глажки штор
д/FOREVER
прямоугольный
150x80CM*

*Recogedor de cortina
rectangular para
FOREVER - 150x80*

*Porte-rideau
rectangulaire pour
FOREVER 150x80 cm*

AR153



**smacchiatore
talco spray
400 ml**

*400ml Talc Stain
Remover Spray*

*Спрей-тальк для
удаления пятен 400
мл*

*pray quitamanchas
de talco de 400 ml*

*Détachant en spray
au talc 400 ml*

RIS1001



**spazzola FACILE
solo vapore**

FACILE steam only br

*простая щетка
только для пара*

*cepillo de vapor
FACILE*

*brosse FACILE à
vapeur*

RIS1002



**spazzola FACILE
PLUS vapore**

*steam brush FACILE
plus*

*паровая щетка
FACILE plus*

*cepillo a vapor FACILE
plus*

*brosse vapeur FACILE
plus*

RIS1005



**spazzola FACILE
stiro secco**

*dry ironing FACILE
brush*

*щетка для сухого
глажения FACILE*

*cepillo FACILE
planchado en seco*

*brosse FACILE pour
repassage à sec*

steam brush SPEEDY
500w natural bristles

cepillo a vapor
SPEEDY de 500 w con
cerdas naturales

паровая щетка
speedy 500 Вт с
натуральными
щетинами
brosse à vapeur
SPEEDY 500w avec
poils naturels

**spazzola
vapore SPEEDY
setole naturali
500w**



codici

AR115S

SPEEDY smooth
steam brush 500w

cepillo a vapor SPEEDY
para planchar de 500 w

паровая щетка
SPEEDY для
глажения 500 Вт

brosse à vapeur
SPEEDY pour le
repassage 500w

**spazzola
vapore SPEEDY
stirante 500w**



AR115B

SPEEDY steam brush
500w 5 poles

cepillo a vapor
SPEEDY de 500 w con
5 postes

Паровая щетка
Speedy 500 Вт с 5
контактами
brosse à vapeur
SPEEDY 500w avec 5
pôles

**spazzola
vapore SPEEDY
500w 5 poli**



AR115E

codici

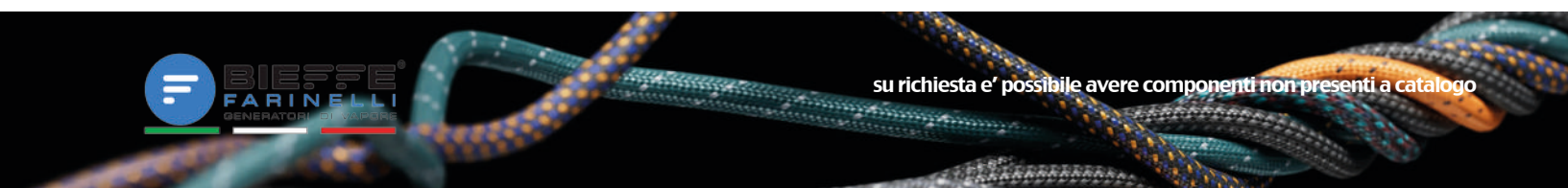

teli e prontotop



covers and
prontotop covers

telas y
prontotop

housse et
prontotop

ТКАНЬ
ЧЕХЛЫ

codici

AR77B



prontotop blu braccetto aspiratore 500x100 cm

Blue Prontotop for Armrest Aspirating Table 500x100 cm

Чехол синий для рукавной колодки 500x100 cm

Prontotop azul para brazo aspirante 500x100 cm

Prontotop Bleu Pour Bras Aspirante 500x100 cm

AR77M



prontotop bianco braccetto aspiratore 500x100 cm

White Prontotop for Armrest Aspirating Table cm 500x100

Чехол белый для рукавной колодки 500x100 cm

500x100 Prontotop blanco para brazo aspirante 500x100 cm

Prontotop Blanc Pour Bras Aspirante 500x100 cm

AR77N



prontotop bianco tavoli BIEFFE FOREVER / JOLLY

White Prontotop for Bieffe Forever / Jolly Tables

Чехол белый для столов Bieffe Forever / Jolly

Prontotop blanco para mesas Bieffe Forever / Jolly

Prontotop Blanc Pour Tables Bieffe Forever / Jolly

AR77



prontotop blu tavoli BIEFFE FOREVER / JOLLY

Blue Prontotop for Bieffe Forever / Jolly Tables

Чехол синий для столов Bieffe Forever / Jolly

Prontotop azul para mesas Bieffe Forever / Jolly

Prontotop Bleu Pour Tables Bieffe Forever / Jolly

AR78



telo copritubo vapore 47x100 cm

steam Tube Cover 47x100 cm

Ткань для покрытия парового шланга 47x100 cm

Cubierta para tubo de vapor 47x100 cm

Housse pour Tuyau Vapeur 47x100 cm

AR13



telo asse aspirante BIEFFE 120x50 cm per BF070 e BF006

Aspirating Board Cover Bieffe 120x50 cm BF070 / BF006

Ткань для утюжильного стола Bieffe 120x50 cm BF070 / BF006

Cubierta para tabla aspirante Bieffe 120x50 cm BF070 / BF006

Housse pour Planche Aspirante Bieffe 120x50 cm BF070 / BF006

Felt 600 for Padding
(Per Meter)

Фетр 600 для
обивки (метр)

**feltro 600 per
imbottitura**



codici

AR123

Fieltro 600 para
acolchado (por metro)

Feltre 600 Pour
Rembourrage (Par
Mètre)

Felt for BF011
Armrest

Фетровая ткань
для рукавной
колодки BF011

**feltro per
braccetto
BF011**



BR6L

Fieltro para brazo
BF011

Feltre Pour Bras
BF011

Felt for Aspirating
Table
BF070 / BF006

Фетровая ткань
для гладильного
стола с аспирац
BF070 / BF006

**feltro per tavolo
aspirante
per BF070 e BF006**



TS4

Fieltro para mesa
aspirante
BF070 / BF006

Feltre Pour Table
Aspirante
BF070 / BF006

Felt for Rectangular
Board BF026
150x80 cm

Фетровая ткань
для прямоуг. стола
BF026 150x80 cm

**feltro per asse
rettangolare
BF026
150x80 cm**



TS4A

Fieltro para tabla
rectangular BF026
150x80 cm

Feltre Pour Axe
Rectangulaire BF026
150x80 cm

Felt for Forever
Rectangular Board
150x80 cm

Фетровая ткань
для прямоуг. стола
Forever 150x80 cm

**feltro per
FOREVER
rettangolare
150x80 mm**



TS4C

Fieltro para Forever
rectangular
150x80 cm

Feltre Pour Forever
Rectangulaire
150x80 cm

Blue Prontotop for
Forever Rectangular
Board 128x50 cm

Чехол синий
для прямоуг.
утюжильного стола
Forever 128x50 cm

**prontotop
blu FOREVER
rettangolare
128x50 mm**



COD0203

Prontotop azul para
Forever rectangular
128x50 cm

Prontotop Bleu Pour
Forever Rectangulaire
128x50 cm

codici

AR47



telo asse famiglia

Family Aspirating
Board Cover

Чехол для
утюжильного
стола Famiglia

Cubierta para tabla
familiar

Housse pour Planche
Familie

BF008CR

tavolo famiglia
silver

chrome plated family
table

хромированный
семейный
гладильный стол

tabla de planchar
familiar cromada

table famille chromee

AR51

telo asse
rettangolare
BF026 111x50 cm

Rectangular Board
Cover for BF026
110x50 cm

Ткань для прямоуг.
утюжильного
стола BF026
110x50 см

Cubierta para tabla
rectangular BF026
110x50 cm

Housse pour Planche
Rectangulaire Pour
BF026 110x50 cm

MAP2101

tessuto lineare
rivestimento
tavoli h. 160 cm

Linear Fabric for Table
Cover h 160 cm

Ткань для обивки
столов h 160 см

Tela lineal para
revestimiento de
mesas h 160 cm

Tissu Linéaire pour
Revêtement de Tables
h 160 cm

AR10

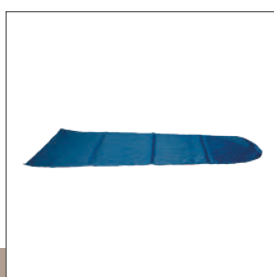
telo asse
aspirante tipo
PONI 130x50 cm

Aspirating Table Cover
Type Poni 130x50 cm

Чехол для стола с
аспирацией типа
Poni 130x50 см

Cubierta para brazo
de planchado tipo
Poni 130x50 cm

Housse pour Planche
Aspirante Type Poni
130x50 cm

COD0211

telo FOREVER
rettangolare
150x80 cm

Forever Rectangular
Board Cover
150x80 cm

Ткань синяя
для прямоуг.
утюжильного стола
Forever 150x80 см
Housse pour Forever
Rectangulaire
150x80 cm

Cubierta Forever
rectangular
150x80 cm

Armrest Cover for
BF011

Ткань синяя для
рукавной колодки
BF011

telo braccetto
stiramaniche per
BF011



codici

AR11L

Housse pour Bras
de Repassage Pour
BF011

Housse pour Bras
de Repassage Pour
BF011

Anti-Glare Ironing
Mat 70x27 cm

Коврик для
глажения против
лоснения 70x27 cm

tappeto
antilucido per
stiro 70x27 cm



AR135

Tapete antirreflejo
para planchado
70x27 cm

Tapis Antireflet pour
Repassage 70x27 cm

Ironing Board Cover
37,5x32,5 cm

Коврик для белья
37,5x32,5 cm

telo poggiapanni
37,5x32,5 cm



TAPP

Cubierta para porta-
ropas 37,5x32,5 cm

Housse pour Panier à
Linge 37,5x32,5 cm

home use medium
blue prontotop
48x128 cm

пронтотоп средний
синий для дома
48x128 cm

prontotop
azzurro
casalingo
medio
48 x 128 cm



RIS3056

prontotop azul
doméstico medio
48x128 cm

prontotop bleu
domestique moyen
48x128 cm

aluminized fabric
sheath 10 meters
Ø 1/2

обмотка из
алюминиевой ткани
10 метров Ø 1/2

guaina in
tessuto
alluminizzato
10 mt Ø 1/2



RIS3057

manguito de tela
aluminizada 10
metros Ø 1/2

gaine en tissu
aluminisé 10 mètres
Ø 1/2

aluminized fabric
sheath 10 meters
Ø 3/8

обмотка из
алюминиевой ткани
10 метров Ø 3/8

guaina in
tessuto
alluminizzato
10 mt Ø 3/8



RIS3058

manguito de tela
aluminizada 10
metros Ø 3/8

gaine en tissu
aluminisé 10 mètres
Ø 3/8

codici

RIS3059



**prontotop
casalingo
piccolo
42x125 cm**

home use small
prontotop
42x125 cm

пронтотоп
маленький для дома
42x125 cm

"prontotop doméstico
pequeño 42x125 cm

" prontotop
domestique petit
42x125 cm

RIS3060



**prontotop
universale
blu braccio
per macchina
industriale
9x14x62 cm**

universal blue
prontotop arm for
industrial machine
9x14x62 cm

пронтотоп универс.
синий для рукава для
промышл. машин
9x14x62 cm

brazo prontotop
universal azul para
máquina industrial
9x14x62 cm

bras prontotop
universel bleu pour
machine industrielle
9x14x62 cm

RIS3061



**telo schiumato
tavolo ind.
33x50x125 mm
sp.10mm d.90
kg/m³**

foam cover 33x50x125
mm f/industrial board th.
10mm dens. 90kg/m³

пенный чехол 33x50x125
мм для промышленной
доски, толщина 10 мм,
плотность 90 кг/м³

tela espumada mesa
de planchado industrial
33x50x125 mm esp.
10mm dens. 90kg/m³

housse en mousse
33x50x125 mm pour
planche industrielle ép. 10
mm dens. 90 kg/m³

**caldaie e
componenti**



**boilers and
components**

calderas y componentes

chaudieres en cuivre

бойлеры и их компоненты

codici

COB1111



**caldaia in rame
BABY VAPOR
2 lt**

*Copper Boiler BABY
VAPOR - 2 liters*

*Бойлер из меди
BABY VAPOR - 2 л*

*Caldera de cobre
BABY VAPOR
2 litros*

*Chaudière en cuivre
BABY VAPOR - 2 litres*

COB1124



**caldaia in rame
automatica
AUTOMATIC VAPOR
2,8 lt 2008**

*Copper Boiler
AUTOMATIC VAPOR
- 2.8 liters*

*Бойлер из меди
AUTOMATIC VAPOR
- 2,8 л*

*Caldera de cobre
AUTOMATIC VAPOR
2.8 litros*

*Chaudière en cuivre
AUTOMATIC VAPOR -
2,8 litres*

C15BVP



**caldaia in rame
blu VAPOR PLUS
2,4 lt**

*Copper Boiler BLU
VAPOR PLUS - 2.4
liters*

*Бойлер из меди BLU
VAPOR PLUS - 2,4 л*

*Caldera de cobre BLU
VAPOR PLUS -
2.4 litros*

*Chaudière en cuivre
BLU VAPOR PLUS -
2,4 litres*

COB1251



**caldaia in rame
CLEAN VAPOR
5 lt**

*Copper Boiler CLEAN
VAPOR - 5 liters*

*Бойлер из меди
CLEAN VAPOR - 5 л*

*Caldera de cobre
CLEAN VAPOR
5 litros*

*Chaudière en cuivre
CLEAN VAPOR
5 litres*

C15CW



**caldaia in rame
CARWASH 3,5 lt**

*Copper Boiler
CARWASH - 3.5 liters*

*Бойлер из меди
CARWASH - 3,5 л*

*Caldera de cobre
CARWASH - 3.5 litros*

*Chaudière en cuivre
CARWASH - 3,5 litres*

C15CWPL



**caldaia in rame
CARWASH PLUS
3,5 lt**

*Copper Boiler
CARWASH PLUS
3.5 liters*

*Бойлер из меди
CARWASH PLUS -
3,5 л*

*Caldera de cobre
CARWASH PLUS
3.5 litros*

*Chaudière en cuivre
CARWASH PLUS
3,5 litres*

Copper Boiler EMILIO
- 2.8 liters

Бойлер из меди
EMILIO - 2,8 л

**caldaia in rame
EMILIO
2,8 lt**



codici

COB1161

Caldera de cobre
EMILIO - 2.8 litros

Chaudière en cuivre
EMILIO - 2,8 litres

Copper Boiler EMILIO
RA / RA PLUS - 2.4
liters

Бойлер из меди
EMILIO RA / RA PLUS
- 2,4 л

**caldaia in rame
EMILIO RA 2009 /
RA PLUS 2,4 lt**



COB1162

Caldera de cobre
EMILIO RA / RA PLUS
- 2.4 litros

Chaudière en cuivre
EMILIO RA / RA PLUS
- 2,4 litres

Copper Boiler CLEAN
VAPOR JUNIOR - 3.5
liters

Бойлер из меди
CLEAN VAPOR
JUNIOR - 3,5 л

**caldaia in rame
CLEAN VAPOR
JUNIOR
3,5 lt**



C15JN

Caldera de cobre
CLEAN VAPOR
JUNIOR - 3.5 litros

Chaudière en cuivre
CLEAN VAPOR
JUNIOR - 3,5 litres

Copper Boiler
MAGIC VAPOR - 2.8
liters

Бойлер из меди
MAGIC VAPOR - 2,8 л

**caldaia in rame
MAGIC VAPOR
2,8 lt**



C15MG

Caldera de cobre
MAGIC VAPOR - 2.8
litros

Chaudière en cuivre
MAGIC VAPOR - 2,8
litres

Copper Boiler ALUR -
2.4 liters

Бойлер из меди
ALUR - 2,4 л

**caldaia in rame
MAGIC VAPOR
ALUR 2,4 lt**



C15MGAL

Caldera de cobre
ALUR - 2.4 litros

Chaudière en cuivre
ALUR - 2,4 litres

Copper Boiler MAGIC
VAPOR RA - 2.8 liters

Бойлер из меди
MAGIC VAPOR RA -
2,8 л

**caldaia in rame
MAGIC VAPOR RA
2,8 lt**



COB1261

Caldera de cobre
MAGIC VAPOR RA -
2.8 litros

Chaudière en cuivre
MAGIC VAPOR RA -
2,8 litres

codici

COB1121



**caldaia in rame
MAXI VAPOR
3,5 lt**

*Copper Boiler MAXI
VAPOR - 3.5 liters*

*Бойлер из меди
MAXI VAPOR - 3,5 л*

*Caldera de cobre
MAXI VAPOR -
3.5 litros*

*Chaudière en cuivre
MAXI VAPOR -
3,5 litres*

COB1101



**caldaia in rame
STIR VAPOR
1,5 lt**

*Copper Boiler STIR
VAPOR - 1.5 liters*

*Бойлер из меди STIR
VAPOR - 1,5 л*

*Caldera de cobre STIR
VAPOR - 1.5 litros*

*Chaudière en cuivre
STIR VAPOR - 1,5 litre*

COB1112



**caldaia in rame
SUPER VAPOR
2 lt**

*Copper Boiler SUPER
VAPOR - 2 liters*

*Бойлер из меди
SUPER VAPOR - 2 л*

*Caldera de cobre
SUPER VAPOR -
2 litros*

*Chaudière en cuivre
SUPER VAPOR -
2 litres*

COB1116



**caldaia in rame
SUPER VAPOR
PLUS
2,4 lt**

*Copper Boiler SUPER
VAPOR PLUS -
2.4 liters*

*Бойлер из меди
SUPER VAPOR PLUS
2,4 л*

*Caldera de cobre
SUPER VAPOR PLUS
- 2.4 litros*

*Chaudière en cuivre
SUPER VAPOR PLUS
- 2,4 litres*

COB1131



**caldaia in rame
FOREVER 3,5 lt
2008**

*Copper Boiler
FOREVER - 3.5 liters*

*Бойлер из меди
FOREVER - 3,5 л*

*Caldera de cobre
FOREVER - 3.5 litros*

*Chaudière en cuivre
CARWASH - 3,5 litres*

COB1132



**caldaia in rame
FOREVER RA
2,8 lt**

*Copper Boiler
FOREVER Automatic
Refill - 2.8 liters*

*Бойлер из меди
FOREVER с
автоматической
закачкой воды - 2,8 л*

*Caldera de cobre
FOREVER Recarga
Automática -
2.8 litros*

*Chaudière en cuivre
FOREVER avec
recharge automatique
- 2,8 litres*

Copper Boiler
TAVOLO - 2 liters

Бойлер из меди
TAVOLO - 2 л

**caldaia in rame
TAVOLO 2 lt**



codici

C15TS

Caldera de cobre
TAVOLO - 2 litros

Chaudière en cuivre
TAVOLO - 2 litres

Copper Boiler
VAPORINO - 1 liter

Бойлер из меди
VAPORINO - 1 л

**caldaia in rame
VAPORINO 1 lt**



C15VP

Caldera de cobre
VAPORINO - 1 litro

Chaudière en cuivre
VAPORINO - 1 litre

copper boiler f/
scarpavapor no limits
- 2,8 liters

бойлер из меди
scarpavapor no limits
- 2,8 л

**caldaia in rame
SCARPA VAPOR
NO LIMITS 2,8 lt**

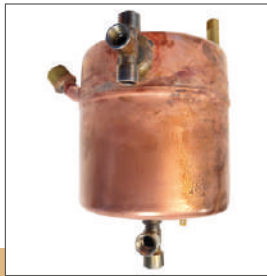

COB1226

caldera de cobre p/
scarpavapor no limits
- 2,8 litros

chaudiere en cuivre p/
scarpavapor no limits
- 2,8 litres

Copper Boiler
SCARPA VAPOR
3 liters

Бойлер из меди
SCARPAVAPOR 3 л

**caldaia in rame
SCARPA VAPOR
3 lt**



COB1277

Caldera de cobre
SCARPA VAPOR
3 litros

Chaudière en cuivre
SCARPA VAPOR
3 litres

Copper Boiler
VAPOBUS

Бойлер из меди
VAPOBUS

**caldaia in rame
VAPOBUS**



C15JB

Caldera de cobre
VAPOBUS

Chaudière en cuivre
VAPOBUS

Copper Boiler
CLEAN VAPOR
5 liters

Бойлер из меди
CLEAN VAPOR 5 л

**caldaia in rame
CLEAN VAPOR
5 lt**

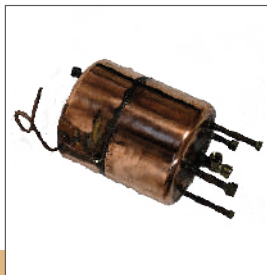

C15CV

Caldera de cobre
CLEAN VAPOR
5 litros

Chaudière en cuivre
CLEAN VAPOR
5 litres

codici

COB1130

**caldaia in rame
AUTOMATIC
VAPOR PLUS**

*AUTOMATIC VAPOR
PLUS copper boiler*

*Медный котел
AUTOMATIC VAPOR
PLUS*

*Caldera de cobre
AUTOMATIC VAPOR
PLUS*

*Chaudière en cuivre
AUTOMATIC VAPOR
PLUS*

COB1274

**caldaia in rame
STEAM 3000
3000 W**

*Copper Boiler STEAM
3000 3000 W*

*Бойлер из меди
STEAM 3000 3000 W*

*Caldera de cobre
STEAM 3000 3000 W*

*Chaudière en cuivre
STEAM 3000 3000 W*

COB1275

**caldaia in rame
STEAM 3000
4500 W**

*Copper Boiler STEAM
3000 4500 W*

*Бойлер из меди
STEAM 3000 4500 W*

*Caldera de cobre
STEAM 3000 4500 W*

*Chaudière en cuivre
STEAM 3000 4500 W*

COB1276

**caldaia in rame
STEAM 3000
6000 W**

*Copper Boiler STEAM
3000 6000 W*

*Бойлер из меди
STEAM 3000 6000 W*

*Caldera de cobre
STEAM 3000 6000 W*

*Chaudière en cuivre
STEAM 3000 6000 W*

COB1317

**caldaia in rame
VAPORDENT
JUNIOR 2,8 lt
ricarica
automatica**

*Copper Boiler
VAPORDENT JUNIOR
- 2,8 liters automatic*

*Бойлер из меди
VAPORDENT
JUNIOR - 2,8 л
автоматическая*

*Caldera de cobre
VAPORDENT JUNIOR
- 2,8 litros
automática*

*Chaudière en cuivre
VAPORDENT JUNIOR
- 2,8 litres
automatique*

COB1319

**caldaia in rame
VAPORDENT
JUNIOR 3,5 lt
ricarica manuale**

*Copper Boiler
VAPORDENT JUNIOR
- 3,5 liters manual*

*Бойлер из меди
VAPORDENT JUNIOR
- 3,5 л
механика*

*Caldera de cobre
VAPORDENT JUNIOR
- 3,5 litros
manual*

*Chaudière en cuivre
VAPORDENT JUNIOR
- 3,5 litres
manuel*

Copper Boiler
VAPORDENT SENIOR
manual

Бойлер из меди
VAPORDENT SENIOR
механика

**caldaia in rame
VAPORDENT
SENIOR
ricarica manuale**

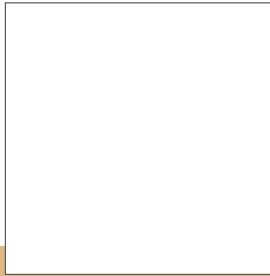

codici

COB1331

Caldera de cobre
VAPORDENT SENIOR
manual

Chaudière en cuivre
VAPORDENT SENIOR
manuel

Copper Boiler
VAPORDENT SENIOR
*automatic/
water*

Бойлер из меди
VAPORDENT SENIOR
*автоматическая/
запасов воды*

**caldaia in rame
VAPORDENT
SENIOR
ricarica
automatica e
idrica**



COB1332

Caldera de cobre
VAPORDENT SENIOR
automática/ de agua

Chaudière en cuivre
VAPORDENT SENIOR
automatique/ en eau

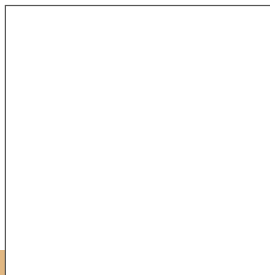

codici

MP145D



**isolante
EUROVER 2at
sp.20 mm rot
0,6x20 cm**

*Insulation Eurover
2ATTh.20mm - Roll
0.6x20 cm*

*Теплоизоляция
Eurover 2AT
толщиной 20 мм -
рулон 0,6x20 см*

*Aislamiento Eurover
2ATTh.20mm - Rollo
0.6x20 cm*

*Isolant Eurover 2AT
épaisseur 20 mm -
Rouleau de 0,6x20 cm*

C39SV



**isolante
STIR VAPOR
9x61 cm**

*Insulation STIR
VAPOR 9x61 cm*

*Теплоизоляция STIR
VAPOR 9x61 см*

*Aislamiento STIR
VAPOR 9x61 cm*

*Isolant STIR VAPOR
9x61 cm*

C39VD



**isolante
VAPORDENT
24,5x61 cm**

*Insulation
VAPORDENT
24.5x61 cm*

*Теплоизоляция
VAPORDENT
24,5X61 см*

*Aislamiento
VAPORDENT
24.5x61 cm*

*Isolant STIR VAPOR
9x61 cm*

C39C



**isolante dischi
copricaldaia
23x22 cm**

*Insulation boiler cover
discs 20x20/22 cm*

*Теплоизоляционные
диски для бойлера
20x20/22 см*

*Discos de cubierta
de aislamiento de
caldera 20x20/22 cm*

*Isolant disques
couverture de chaudière
20x20/22 cm*

C39EM



**isolante
EMILIO/MAGIC/
FOREVER RA
16x61 cm**

*Insulation EMILIO/
MAGIC/FOREVER RA
16x61 cm*

*Теплоизоляция
EMILIO/MAGIC/
FOREVER RA
16X61 см*

*Aislamiento EMILIO/
MAGIC/FOREVER RA
16x61 cm*

*Isolant EMILIO/
MAGIC/FOREVER RA
16x61 cm*

C39BL



**isolante
EMILIO RA/
MAGIC RA/BLU V
PLUS
15x61 cm**

*Insulation BLU V
PLUS/EMILIO RA/
MAGIC RA 15x61 cm*

*Теплоизоляция BLU
V PLUS/EMILIO RA/
MAGIC RA 15X61 см*

*Aislamiento BLU V
PLUS/EMILIO RA/
MAGIC RA 15x61 cm*

*Isolant BLU V PLUS/
EMILIO RA/MAGIC RA
15x61 cm*

Insulation CAR W/
CLEAN V J/MAXI/
FOREVER 20x61 cm

Теплоизоляция CAR
W/CLEAN V J/MAXI/
FOREVER 20x61 см

**isolante CAR W/
CLEAN V J MAXI/
FOREVER
20x61 cm**



codici

C39CW

Aislamiento CAR W/
CLEAN V J/MAXI/
FOREVER 20x61 cm

Isolant CAR W/CLEAN
V J/MAXI/FOREVER
20x61 cm

Insulation MAXI
VAPOR PLUS
28x61 cm

Теплоизоляция
MAXI VAPOR PLUS
28x61 см

**isolante MAXI
VAPOR PLUS
28x61 cm**



C39MV

Aislamiento MAXI
VAPOR PLUS
28x61 cm

Isolant MAXI VAPOR
PLUS 28x61 cm

Insulation CLEAN V/
STEAM 22x68 cm

Теплоизоляция
CLEAN V/STEAM
22x68 см

**isolante
CLEAN V / STEAM
22x68 cm**



C39CV

Aislamiento CLEAN V/
STEAM 22x68 cm

Isolant CLEAN V/
STEAM 22x68 cm

Insulation BABY
VAPOR/SUPER
VAPOR/SUPER VAPOR
PLUS 12x61 cm

Теплоизоляция
BABY VAPOR/SUPER
VAPOR/SUPER VAPOR
PLUS 12x61 см

**isolante
BABY VAPOR/
SUPER VAPOR/
SUPER VAPOR
PLUS
12x61 cm**



C39BV

Aislamiento BABY
VAPOR/SUPER
VAPOR/SUPER VAPOR
PLUS 12x61 cm

Isolant BABY VAPOR/
SUPER VAPOR/SUPER
VAPOR PLUS 12x61 cm



codici

CV50



**sonda livello
caldaia CLEAN
VAPOR 130 mm
230 V**

*Boiler Level Probe
"CLEAN VAPOR" 130
mm 230V*

*Датчик уровня воды
в бойлере CLEAN
VAPOR 130 мм 230В*

*Sonda de nivel de
caldera "CLEAN
VAPOR" 130 mm 230V*

*Sonde niveau
chaudière "CLEAN
VAPOR" 130 mm 230V*

CW53



**sonda livello
caldaia CARWASH
120 mm**

*Boiler Level Probe
CARWASH 120 mm*

*Датчик уровня воды
в бойлере CARWASH
120 мм*

*Sonda de nivel de
caldera CARWASH
120 mm*

*Sonde niveau
chaudière CARWASH
120 mm*

EM50



**sonda livello
caldaia EMILIO
RA 100 mm**

*Boiler Level Probe
EMILIO RA 100 mm*

*Датчик уровня воды
в бойлере EMILIO RA
100 мм*

*Sonda de nivel de
caldera EMILIO RA
100 mm*

*Sonde niveau
chaudière EMILIO RA
100 mm*

AVC



**sonda livello
caldaia
AUTOMATIC
VAPOR 120 mm**

*Boiler Level Probe
AUTOMATIC VAPOR
120 mm*

*Датчик уровня
воды в бойлере
AUTOMATIC VAPOR*

*Sonda de nivel de
caldera AUTOMATIC
VAPOR 120 mm*

*Sonde niveau chaudière
AUTOMATIC VAPOR
120mm*

MG13



**Sonda livello
CLEAN VAPOR
JUNIOR / MAGIC
RA 110 mm**

*Boiler Level Probe
CLEAN VAPOR
JUNIOR / MAGIC RA
110 mm*

*Датчик уровня воды
в бойлере CLEAN
VAPOR JUNIOR /
MAGIC RA 110 мм*

*Sonda de nivel de
caldera CLEAN VAPOR
JUNIOR / MAGIC RA
110 mm*

*Sonde niveau CLEAN
VAPOR JUNIOR /
MAGIC RA 110 mm*

CV50B

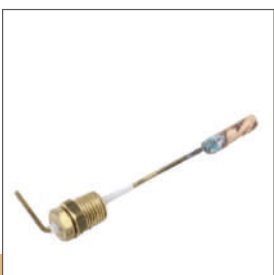

**sonda livello
caldaia CLEAN
VAPOR 120 mm
380 V**

*Boiler Level Probe
CLEAN VAPOR 120
mm 380V*

*Датчик уровня воды
в бойлере CLEAN
VAPOR 120 мм 380В*

*Sonda de nivel de
caldera CLEAN
VAPOR 120 mm 380V*

*Sonde niveau
chaudière CLEAN
VAPOR 120 mm 380V*

Boiler Level Probe Датчик уровня воды
BF4000 above 120 в бойлере BF4000
mm сверху 120 мм

Sonda de nivel de Sonde niveau
caldera BF4000 chaudière BF4000 au-
superior 120 mm dessus 120 mm

**sonda livello
caldaia BF4000
sopra 120 mm**

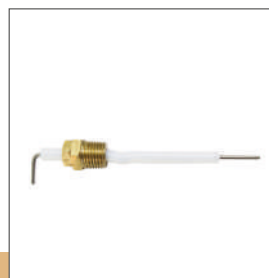

codici

COB0301

Boiler Level Probe Датчик уровня воды
BF4000 below в бойлере BF4000
145 mm снизу 145 мм

Sonda de nivel de Sonde niveau
caldera BF4000 chaudière BF4000 en
inferior 145 mm dessous 145 mm

**sonda livello
caldaia BF4000
sotto 120 mm**

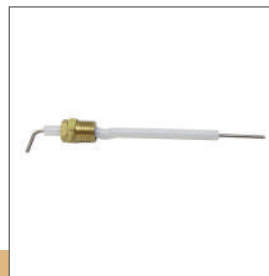

COB0302

Boiler Level Control Измеритель
Rod - L 22cm контроля уровня воды
в бойлере - L 22 см

Varilla de control de Tige de contrôle de
nivel de caldera - niveau de chaudière -
L 22cm L 22cm

**asta controllo
livello caldaia
L 22 cm**

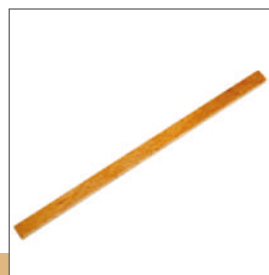

AR166



codici

C23

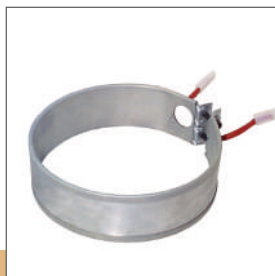

resistenza fascia
Ø 160x45 mm
1000W

Heating Element Band
Ø 160x45 mm 1000W

Нагревательный
элемент в форме
кольца Ø 160x45 mm
1000W

Banda de Resistencia
Ø 160x45 mm 1000W

Résistance bande Ø
160x45 mm 1000W

C23B

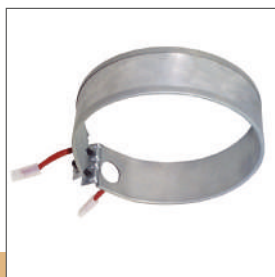

resistenza fascia
Ø 160x45 mm
MAGIC VAPOR RA

Heating Element Band
Ø 160x45 mm - Magic
Vapor RA

Нагревательный
элемент в форме
кольца Ø 160x45 mm -
Magic Vapor RA

Banda de Resistencia
Ø 160x45 mm - Magic
Vapor RA

Résistance bande Ø
160x45 mm - Magic
Vapor RA

C23M



resistenza fascia
Ø 160x60 mm
1300W

Heating Element Band
Ø 160x60 mm 1300W

Нагревательный
элемент в форме
кольца Ø 160x60 mm
1300W

Banda de Resistencia
Ø 160x60 mm 1300W

Résistance bande Ø
160x60 mm 1300W

CV23



resistenza fascia
Ø 180x55 mm
230V 1500W

Heating Element Band
Ø 180x55 mm 230V
1500W

Нагревательный
элемент в форме
кольца Ø 180x55 mm
230V 1500W

Banda de Resistencia
Ø 180x55 mm 230V
1500W

Résistance bande
Ø 180x55 mm 230V
1500W

AR187



resistenza
1500W/1650W
180 mm 1/4

Heating Element
1500W/1650W 180
mm 1/4

Нагревательный
элемент
1500W/1650W 180 mm
1/4

Resistencia
1500W/1650W 180
mm 1/4

Résistance
1500W/1650W 180 mm
1/4

AR187B

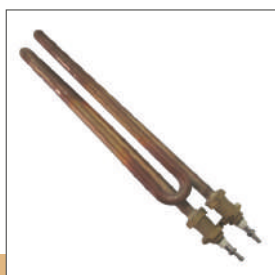

resistenza 2000W
180 mm 1/4

Heating Element
2000W 180 mm 1/4

Нагревательный
элемент 2000W
180 mm 1/4

Resistencia 2000W
180 mm 1/4

Résistance 2000W
180 mm 1/4

codici

Heating Element
SK 1/2M Cartridge
40/190MM 1500W

Внутренний
нагревательный
элемент SK 1/2M
40/190 мм 1500W

**resistenza
cartuccia SK
1/2M
40/190 mm
1500W**



C1100

Resistencia SK 1/2M
Cartucho 40/190MM
1500W

Résistance cartouche
SK 1/2M 40/190MM
1500W

Heating Element SK
1/2M Gas Cartridge
110MM 1000W

Внутренний
нагревательный
элемент SK 1/2M Gas
110 мм 1000W

**resistenza
cartuccia SK
1/2M GAS 110
mm 1000W**



C1100D

Resistencia SK 1/2M
Cartucho de gas
110MM 1000W

Résistance cartouche
SK 1/2M Gaz 110MM
1000W

Cartridge Heating
Element Ø 16 280 mm
1800W

Внутренний
нагревательный
элемент Ø 16 280

**resistenza
cartuccia Ø 16
280 mm 1800W**



COE1251

Resistencia de
cartucho Ø 16 280
mm 1800W

Résistance cartouche
Ø 16 280 mm 1800W

Heating Element Coil
80 mm 3000W 3/8

Нагревательный
элемент винтовой
80 мм 3000W 3/8

**resistenza
torciglione
80 mm 3000W
3/8**



COE1302

Resistencia Bobina 80
mm 3000W 3/8

Résistance torsadée 80
mm 3000W 3/8

Heating Element
Folded 165 mm 3000W
3/8

Нагревательный
элемент изогнутый
165 мм 3000W 3/8

**resistenza
ripiegata
165 mm 3000W
3/8**



COE1303

Resistencia Plegado
165 mm 3000W 3/8

Résistance repliée 165
mm 3000W 3/8

Heating Element
Eyelet 175 mm 1500W
1/4

Нагревательный
элемент с
отверстием для
датчика 175 мм 1500W
1/4

**resistenza
occhiello
175 mm 1500W
1/4**



COE1304

Resistencia Ojal 175
mm 1500W 1/4

Résistance à œillet 175
mm 1500W 1/4

codici

COE1305



**resistenza
occhiello con
porta sonda
120 mm 1650W
1/4**

Heating Element
Eyelet with Probe Port
120 mm 1650W 1/4

Resistencia Ojal con
porta sonda 120 mm
1650W 1/4

Нагревательный
элемент с
отверстием для
датчика 120 мм 1650W
1/4

Résistance œillet avec
porte sonde 120 mm
1650W 1/4

COE1306



**resistenza
occhiello con
porta sonda
150 mm 1000W**

Heating Element
Eyelet with Probe
Port 150 mm 1000W

Resistencia Ojal con
porta sonda 150 mm
1000W

Нагревательный
элемент с отверстием
для датчика 150 мм
1000W

Résistance à œillet
avec porte sonde
150 mm 1000W

COE1307



**resistenza
occhiello con
porta sonda
140 mm 1200W**

Heating Element
Eyelet with Probe Port
140 mm 1200W

Resistencia Ojal con
porta sonda 140 mm
1200W

Нагревательный
элемент с
отверстием для
датчика 140 мм
1200W

Résistance à œillet
avec porte sonde
140 mm 1200W

VR07



**riscaldatore
acqua 170 mm
1000W**

Water Heater 170 mm
1000W

Calentador de agua
170 mm 1000W

Водонагреватель
170 мм 1000W

Chauffe-eau 170 mm
1000W

C221



**supporto
riscaldatore
VR07 forma U
135 mm**

Heating Element
Support VR07 "U"
Shape 135 mm

Soporte de
Resistencia VR07
Forma "U" 135 mm

Кронштейн для
водонагревателя
VR07 форма "U" 135
мм

Support de chauffe-
eau VR07 forme "U"
135 mm

CW07



**riscaldatore aria
CARWASH**

CAR WASH Air Heater

Calentador de aire
CAR WASH

Обогреватель
воздуха CAR WASH

Chauffe-air
CAR WASH

hot air resistance with
nuts 230V 1400W

сопротивление
горячему воздуху с
гайками 230В 1400Вт

**resistenza aria
calda con dadi
230V 1400W**

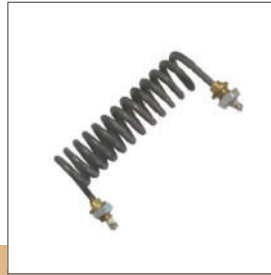

codici

COE1051

resistencia de aire
caliente con tuercas
230V 1400W

résistance à air chaud
avec écrous 230V
1400W

Mica resistance for iron
800W

Слюдяное
сопротивление для
железа 800Вт

**resistenza in
mica per ferro
800W**



AR6

Resistencia de mica
para plancha 800W

Résistance mica pour
fer 800W

1000W armored iron
resistance

Сопротивление
бронированному
железу 1000 Вт

**resistenza ferro
corazzata 1000W**



AR7C

Resistencia de hierro
blindado de 1000W

Résistance en fer blindé
1000W

Armored resistance for
sleeve iron arm 100W
220V 450x50mm

Броневое сопротивление
для рукавной железной
руки 100Вт 220В
450x50мм

**resistenza
corazzata
braccetto
stiramanche
100W 220V
450x50mm**



BR5

Resistencia blindada
para brazo de hierro
manga 100W 220V
450x50mm

Résistance blindée pour
bras en fer à manchon
100W 220V 450x50mm

Armored table
resistor 700W 220V
1070x220mm

Резистор
бронированный
настольный 700Вт
220В 1070x220мм

**resistenza
corazzata tavolo
700W 220V
1070x220mm**

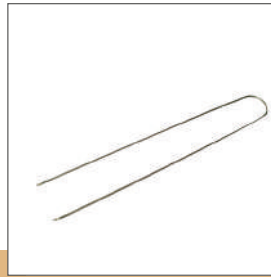

TS8

Resistencia de mesa
blindada 700W 220V
1070x220mm

Résistance de table
blindée 700W 220V
1070x220mm

JOLLY armored table
heating element 700W
220V 1070x220 mm

Нагревательный
элемент настольный
бронированный JOLLY
700Вт 220В 1070x220 мм

**resistenza
corazzata tavolo
JOLLY 700W 220V
1070x220 mm**

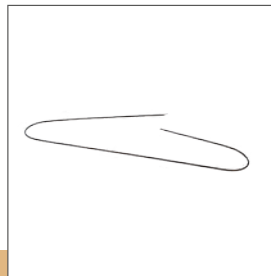

TS8J

Resistencia de mesa
blindada JOLLY 700W
220V 1070x220 mm

Élément chauffant
de table blindé JOLLY
700W 220V 1070x220
mm

codici

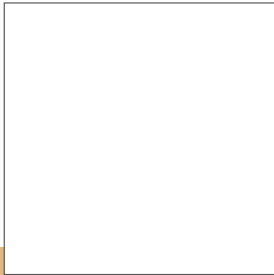

elettrovalvole e manopole



solenoid valves and knobs

electrovalvulas y perillas

electrovannes et boutons

**электромагнитные
клапаны и ручки**

codici

C18G/OL



**elettrovalvola
VAP 1/4 REG PG
12W OLAB**

*Steam Solenoid Valve
1/4 Adjustable PG
12W OLAB*

*Электромагнитный
клапан пара 1/4
регулируемый PG
12W OLAB*

*Válvula solenoide de
vapor 1/4 ajustable
PG 12W OLAB*

*Électrovanne vapeur
1/4 réglable PG 12W
OLAB*

C18G



**elettrovalvola
VAP 1/4 reg
PG 12W CEME**

*Steam Solenoid Valve
1/4 Adjustable PG
12W CEME*

*Электромагнитный
клапан пара 1/4
регулируемый PG
12W CEME*

*Válvula solenoide de
vapor 1/4 ajustable
PG 12W CEME*

*Électrovanne vapeur
1/4 réglable PG 12W
CEME*

C37S



**elettrovalvola
VAP 1/8 M P
gomma 6W**

*Steam Solenoid Valve
1/8 M.P. Rubber 6W*

*Электромагнитный
клапан пара 1/8
M.P.Gomma 6W*

*Válvula solenoide de
vapor 1/8 M.P.
Caucho 6W*

*Électrovanne vapeur
1/8 M.P.Gomma 6W*

AR16



**bobina
elettrovalvola
6W CEME**

*Solenoid Valve Coil
6W - CEME*

*Катушка для
электромагнитного
клапана 6W - CEME*

*Bobina de válvula
solenoid 6W - CEME*

*Bobine électrovanne
6W - CEME*

AR16B



**bobina
elettrovalvola
6W OLAB**

*Solenoid Valve Coil
6W - OLAB*

*Катушка для
электромагнитного
клапана 6W - OLAB*

*Bobina de válvula
solenoid 6W - OLAB*

*Bobine électrovanne
6W - OLAB*

AR39

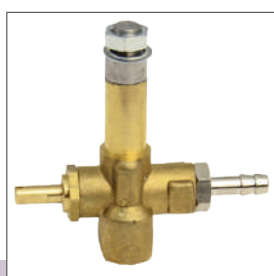

**corpo elettrov.
1/4 fr. pg 6W
CEME c/da**

*Solenoid Valve Body
1/4 F Adjustable 6W -
CEME*

*Корпус
электромагнитного
клапана 1/4 F
регулируемый 6W -
CEME*

*Cuerpo de válvula
solenoid 1/4 hembra
ajustable 6W - CEME*

*Corps électrovanne
1/4 F réglable 6W -
CEME*

Solenoid Valve Body
1/4F Adjustable 6W -
OLAB

Корпус
электромагнитного
клапана 1/4F
регулируемый 6W -
OLAB

Cuerpo de válvula
solenoid 1/4 hembra
ajustable 6W - OLAB

Corps électrovanne
1/4F réglable 6W -
OLAB

**corpo
elettrovalvola
1/4f reg pg
6W OLAB**



codici

AR39B

Solenoid Valve Body
1/4F Adjustable 12W
- CEME

Корпус
электромагнитного
клапана 1/4F
регулируемый 12W -
CEME

Cuerpo de válvula
solenoid 1/4 hembra
ajustable 12W - CEME

Corps électrovanne
1/4F réglable 12W -
CEME

**corpo
elettrovalvola
1/4f reg
12W CEME**



AR39G

45° Solenoid Valve
Body 1/4F PG 6W
with nut - CEME

Корпус
электромагнитного
клапана 45° 1/4F PG
6W с гайкой - CEME

Cuerpo de válvula
solenoid 45° 1/4
hembra PG 6W con

Corps électrovanne
45° 1/4F PG 6W avec
écrou - CEME

**corpo
elettrovalvola
45° 1/4 f pg 6W**



AR39P

Steam Solenoid Valve
1/4 F Adjustable PG
6W - CEME

Электромагнитный
клапан пара 1/4 F
регулируемый PG 6W
- CEME

Válvula solenoid 45°
de vapor 1/4 hembra
ajustable PG 6W -
CEME

Électrovanne vapeur
1/4 F réglable PG 6W
- CEME

**elettrovalvola
VAP 1/4 F reg
PG 6W CEME**

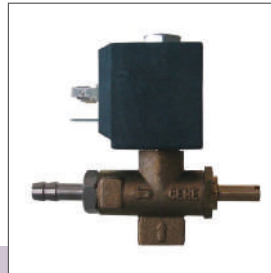

C18

Steam Solenoid Valve
1/4 F Adjustable PG
6W - OLAB

Электромагнитный
клапан пара 1/4 F
регулируемый PG
6W - OLAB

Válvula solenoid 45°
de vapor 1/4 hembra
ajustable PG 6W -
OLAB

Électrovanne vapeur
1/4 F réglable PG 6W
- OLAB

**elettrovalvola
VAP 1/4 F reg
PG 6W OLAB**

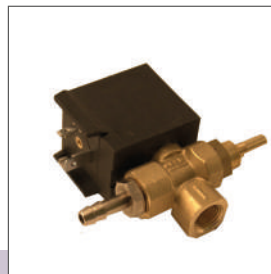

C18/OL

45° Steam Solenoid
Valve 1/4 F PG 6W

Электромагнитный
клапан пара 45° 1/4
F PG 6W

Válvula solenoid
de vapor de 45° 1/4
hembra PG 6W

Électrovanne vapeur
45° 1/4 F PG 6W

**elettrovalvola
VAP 45° 1/4 F
PG 6W**



C38

codici

C38A



**elettrovalvola
VAP 45° 1/4 F
PG 6W 110/120V**

*45° Steam Solenoid
Valve 1/4 F PG 6W
120V*

*Электромагнитный
клапан пара 45° 1/4
F PG 6W 120V*

*Válvula solenoide
de vapor de 45° 1/4
hembra PG 6W 120V*

*Électrovanne vapeur
45° 1/4 F PG 6W 120V*

COE2018



**elettrovalvola
VAP 1/4 FF 6W**

*Steam Solenoid Valve
1/4 FF 6W*

*Электромагнитный
клапан пара 1/4 FF
6W*

*Válvula solenoide de
vapor 1/4 hembra a
hembra 6W*

*Électrovanne vapeur
1/4 FF 6W*

C36



**bobina
elettrovalvola
CEME 4W**

*Solenoid Valve Coil
4W*

*Катушка для
электромагнитного
клапана 4W*

*Bobina de válvula
solenoid 4W*

*Bobine électrovanne
4W*

C37



**elettrovalvola
VAP 1/8 m.
portagomma
4W**

*Steam Solenoid Valve
1/8 M.P. Rubber 4W*

*Электромагнитный
клапан пара 1/8
M.P. Gomma 4W*

*Válvula solenoide
de vapor 1/8 M.P.
Caucho 4W*

*Électrovanne vapeur
1/8 M.P. Gomma 4W*

COE0401



**connettore
bobina 6W/12W
330 mm
completo**

*Coil Connector
6W/12W 330mm
complete*

*Разъем для
катушки 6W/12W
330 мм полный*

*Conector de bobina
6W/12W completo de
330 mm*

*Connecteur de bobine
6W/12W 330mm
complet*

COE2061



**bobina 230V
5W
elettrovalvola
aria**

*Air Solenoid Valve Coil
230V 5W*

*Катушка для
электромагнитного
клапана воздуха 230V
5W*

*Bobina de válvula
solenoid de aire
230V 5W*

*Bobine électrovanne
air 230V 5W*

Air Solenoid Valve
Body 24/230V

Корпус
электромагнитного
клапана воздуха
24/230V

Cuerpo de válvula
solenoid de aire
24/230V

Corps électrovanne air
24/230V

**corpo
elettrovalvola
aria 24-230V**



codici

COE2062

Solenoid Valve Coil
12W - CEME

Катушка для
электромагнитного
клапана 12W - CEME

Bobina de válvula
solenoid 12W -
CEME

Bobine électrovanne
12W - CEME

**bobina
elettrovalvola
12W CEME**

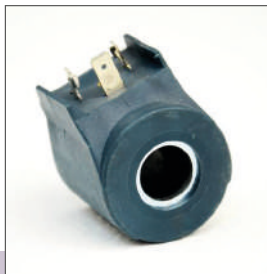

AR113

Solenoid Valve Coil
12W - OLAB

Катушка для
электромагнитного
клапана 12W - OLAB

Bobina de válvula
solenoid 12W -
OLAB

Bobine électrovanne
12W - OLAB

**bobina
elettrovalvola
12W OLAB**



COE2055

Steam Regulation
Knob

Ручка для
регулировки пара

Perilla de regulación
de vapor
CEME

Poignée de réglage de
vapeur

**manopola
regolazione
vapore**



AR24

Steam Regulation
Knob with Compass

Ручка для
регулировки пара с
компасом

Perilla de regulación
de vapor con brújula

Poignée de réglage de
vapeur avec boussole

**manopola
regolazione
vapore con
bussola**



COD0601

OLAB Steam
Regulation Knob

Ручка для
регулировки пара
OLAB

Perilla de regulación
de vapor OLAB

Poignée de réglage de
vapeur OLAB

**manopola
regolazione
vapore OLAB**



AR24/0

codici

**3.003.34.
010ST**



**elettrovalvola
anticalcare per
BF4000**

*anti-limescale
solenoid valve for
BF4000*

*Электромагнитный
клапан защиты
от накипи для
BF4000*

*Válvula solenoide
antical por
BF4000*

*Électrovanne
anticalcaire pour
BF4000*

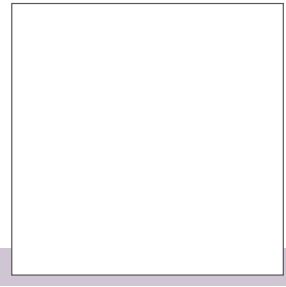
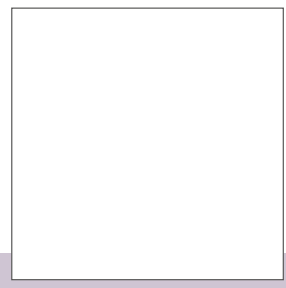
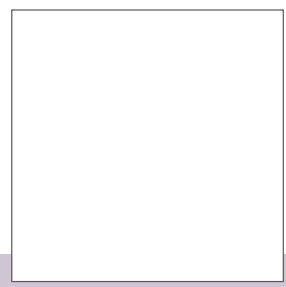
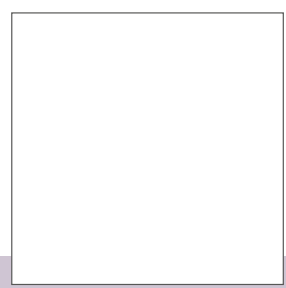

pressostati e termostati



pressureswitches
heating elements

presostatos
termostatos

pressostats
thermostats

датчики давления
термостаты

codici

C22



**pressostato
1/4 3 bar CEME**

Pressure Switch 1/4 3 bar Датчик давления 1/4 3 бара

Interruptor de presión 1/4 3 bar Pressostat 1/4 3 bar

C22A



**pressostato
1/8 3 bar**

Pressure Switch 1/8 3 bar Датчик давления 1/8 3 бара

Interruptor de presión 1/8 3 bar Pressostat 1/8 3 bar

C22F

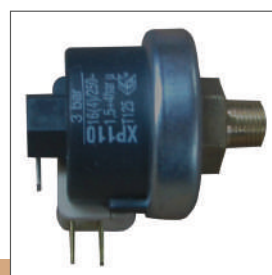

**pressostato
1/8 c/micro
5 bar xp**

Pressure Switch 1/8 with micro 5 bar Датчик давления 1/8 с микропереключателем 5 бар

Interruptor de presión 1/8 con micro 5 bar Pressostat 1/8 avec micro 5 bar

C22H

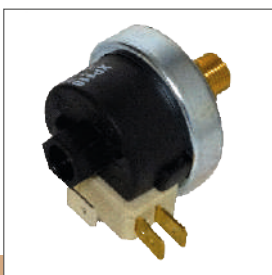

**pressostato
1/8 c/micro
6 bar gp**

Pressure Switch 1/8 with micro 6 bar Датчик давления 1/8 с микропереключателем 6 бар

Interruptor de presión 1/8 con micro 6 bar Pressostat 1/8 avec micro 6 bar

C22L

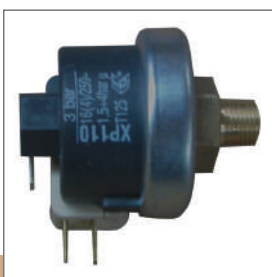

**pressostato
1/8 c/micro
4 bar gp**

Pressure Switch 1/8 with micro 4 bar Датчик давления 1/8 с микропереключателем 4 бар

Interruptor de presión 1/8 con micro 4 bar Pressostat 1/8 avec micro 4 bar

C22M



**pressostato
1/4 c/micro
4,5 bar**

Pressure Switch 1/4 with micro 4,5 bar Датчик давления 1/4 с микропереключателем 4,5 бар

Interruptor de presión 1/4 con micro 4,5 bar Pressostat 1/4 avec micro 4,5 bar

Pressure Switch 1/8 with micro 3 bar Датчик давления 1/8 с микропереключателем 3 бара

Interruptor de presión 1/8 con micro 3 bar Pressostat 1/8 avec micro 3 bar

pressostato 1/8 c/micro 3 bar (ul/etl)

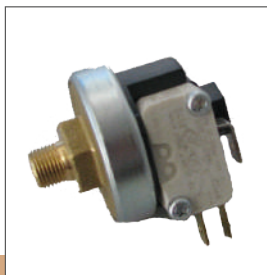

codici

C22NA

Pressure Switch 1/4 with micro 3 bar Датчик давления 1/4 с микропереключателем 3 бара

Interruptor de presión 1/4 con micro 3 bar Pressostat 1/4 avec micro 3 bar

pressostato 1/4 c/micro 3 bar



C22P

Pressure Switch 1/8 with micro 3 bar Датчик давления 1/8 с микропереключателем 3 бара

Interruptor de presión 1/8 con micro 3 bar tuerca - CEME Pressostat 1/8 avec micro 3 bar

pressostato 1/8 c/micro 3 bar

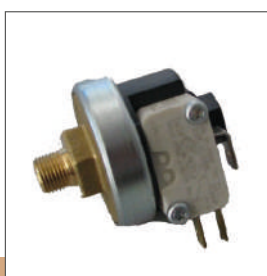

C22N

Pressure Switch 1/4 with micro 6 bar Датчик давления 1/4 с микропереключателем 6 бар

Interruptor de presión 1/4 con micro 6 bar CEME Pressostat 1/4 avec micro 6 bar

pressostato 1/4 c/micro 6 bar



CV22C

Pressure Switch 1/4 micro XP 111 9,5 bar Датчик давления 1/4 микропереключателем XP 111 9,5 бар

Interruptor de presión 1/4 micro XP 111 9,5 bar Pressostat 1/4 micro XP 111 9,5 bar

pressostato 1/4 c/micro xp 111 9,5 bar



C22G



codici

COE2251

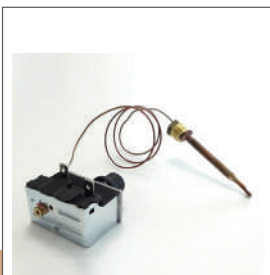

**termostato
195°C capillare in
rame bulbo
6 mm**

*Thermostat 195°C
copper capillary 6 mm
bulb*

*Термостат 195°C,
медный капилляр,
диам. 6 мм*

*Termostato 195°C
con bulbo de cobre de
6 mm*

*Thermostat 195°C
capillaire en cuivre
bulbe 6 mm*

COE2252

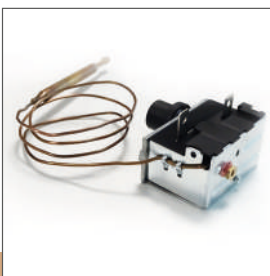

**termostato
173°C capillare in
rame bulbo
6 mm**

*Thermostat 173°C
copper capillary 6 mm
bulb*

*Термостат 173°,
медный капилляр,
диам. 6 мм*

*Termostato 173°C con
bulbo de cobre de 6
mm*

*Thermostat 173°
capillaire en cuivre
bulbe 6 mm*

CV26



**termostato TY60
180°C**

*Thermostat TY60
180°C*

*Термостат TY60
180°C*

*Termostato TY60
180°C*

*Thermostat TY60
180°C*

C26



**termostato TY60
145°C
con staffa**

*Thermostat TY60
145°C with bracket*

*Термостат TY60
145°C с крепежным
кронштейном*

*Termostato TY60
145°C con soporte*

*Thermostat TY60
145°C avec support*

C26A



**termostato TY60
80°C
completo**

*Thermostat TY60
180°C complete*

*Термостат TY60
180°C, в сборе*

*Termostato TY60
180°C completo*

*Thermostat TY60
180°C complet*

C26F



**termostato TY60
165°C
con flangia**

*Thermostat TY60
165°C with flange*

*Термостат TY60 165°C
с фланцем*

*Termostato TY60
165°C con brida*

*Thermostat TY60
165°C avec bride*

Thermostat TY60
120°C complete

Термостат TY60
120°C, в сборе

**termostato TY60
120°C
completo**



codici

C26G

Thermostat TY60
120°C complet

Termostato TY60
120°C completo

Thermostat TY60
155°C with bracket

Термостат TY60
155°C с крепежным
кронштейном

**termostato TY60
155°C
con staffa**



C26B

Termostato TY60
155°C con soporte

Thermostat TY60
155°C avec support

Thermostat snap-
action 165°C manual
reset

Термостат 165°C с
ручным сбросом

**termostato
pastiglia 165°C
riarmo manuale**



COE2260

Termostato de acción
rápida 165°C con
reinicio manual

Thermostat pastille
165°C réarmement
manuel

Thermostat snap-
action 175°C manual
reset

Термостат 175°C с
ручным сбросом

**termostato
pastiglia 175°C
riarmo manuale**



COE2261

Termostato de acción
rápida 175°C con
reinicio manual

Thermostat pastille
175°C réarmement
manuel

thermostat 203°
copper terminal detail
6 mms

термостат 203°,
медный капилляр,
диам. 6 мм

**termostato
203°C capillare
rame bulbo 6 mm**

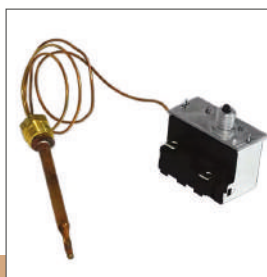

COE2253

termostato 203° con
6 mm

thermostat 203°
capillaire en cuivre
bulbe 6mm

thermostat 30/90°
with full adjustment

термостат 30/90°
с полной регулировкой

**termostato
30/90°
con regolazione
completo**



TS10

termostato 30/90°
con ajuste completo

thermostat 30/90°
avec réglage complet

codici

**valvole di sicurezza,
tappi e guarnizioni**



BIEFFE®
FARINELLI
GENERATORI DI VAPORE

**safety valves
plugs and gaskets**

**valvulas de seguridad,
tapones y juntas**

**soupapes de securite,
bouchons et joints**

**клапаны безопасности,
крышки и уплотнения**

codici

R701



**valvola sicurezza
in ottone C10-3/8
10 bar**

*Brass Safety Valve
C10-3/8 10 bar*

*Клапан
безопасности из
латуни C10-3/8 10*

*Válvula de seguridad
de latón C10-3/8
10 bar*

*Souape de sécurité
en laiton C10-3/8
10 bar*

R703



**valvola sicurezza
1/8 M 7 bar**

*Safety Valve 1/8m
7 BAR*

*Клапан
безопасности 1/8
"мама" 7 бар*

*Válvula de seguridad
1/8 macho 7 bar*

*Souape de sécurité
1/8m 7 bar*

ST4002



**valvola di
sicurezza
convogliatore
3/8 11 bar**

*Conveyor Safety
Valve 3/8 11 bar*

*Клапан
безопасности 3/8
11 бар*

*Válvula de seguridad
de transportador 3/8
11 bar*

*Souape de sécurité
Convogliatore 3/8
11 bar*

AR48



**tappo antisvito
3/4 F.5 bar**

*Safety cap unscrew
proof 3/4 F. 5 bar*

*Противоот
винчивающаяся
крышка 3/4 "мама"
5 бар*

*Tapón antical 3/4
hembra 5 bar*

*Bouchon antivissage
3/4 F. 5 bar*

C50



**tappo antisvito
3-4 tondo 7 bar**

*Safety cap unscrew
proof 3/4 F. Round 7
bar*

*Противоот
винчивающаяся
крышка 3/4 "мама"
круглая 7 бар комплек*

*Tapón antical 3/4
hembra redondo 7 bar*

*Bouchon antivissage
3/4 F. Rond 7 bar*

C24



**tappo 3/4 F
sicurezza 5 bar
guarnizione**

*Safety Cap 3/4 F 5 bar
with Gasket*

*Предохранительный
клапан 3/4 "мама"
5 бар, с
уплотнением*

*Tapa de seguridad
3/4 hembra 5 bar con
junta*

*Bouchon 3/4 F.
Sécurité 5 bar Joint*

Gas Plug 3/8 M 5 bar Предохранительный
клапан 3/8 Gas "papa"
5 BAR

**tappo 3/8 gas M.
5 bar**



codici

C25

Tapón de gas 3/8 macho 5 bar Bouchon 3/8 Gaz M.
5 bar

Gas Plug 1/2 F 5 bar Предохранительный
клапан 1/2 Gas "mama"
5,0 BAR

**tappo 1/2 gas F.
5 bar**



C32

Tapón de gas 1/2 hembra 5 bar Bouchon 1/2 Gaz F.
5 bar

Gas Plug 1/2 M 5 bar Предохранительный
клапан 1/2 Gas "papa"
5 BAR

**tappo 1/2 gas M.
5 bar**



C32M

Tapón de gas 1/2 macho 5 bar Bouchon 1/2 Gaz M.
5 bar

Safety Cap 3/4 F 5 bar with Gasket Предохранительный
клапан 3/4 "mama" 5
бар, с уплотнением

**tappo 3/4 F
sicurezza 5 bar
guarnizione**



CV24

Tapa de seguridad 3/4 hembra 5 bar con junta Bouchon 3/4 F. Sécurité
5 bar Joint

Safety Cap 3/4 F 8 bar VITON Предохранительный
клапан 3/4 "mama"
8 bar VITON

**tappo 3-4 f
sicurezza 8 bar
viton**



C24B

Tapa de seguridad 3/4 hembra 8 bar VITON Bouchon 3/4 F.
Sécurité 8 bar VITON



codici

AR3

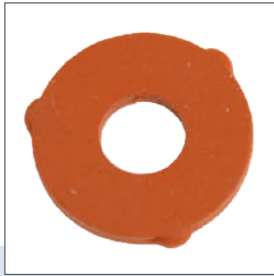

**guarnizione per
tappo 3/4 gas F.**

*Gasket for 3/4 Gas F.
Plug*

*Уплотнительная
прокладка для
клапана 3/4 Gas
"Мама"*

*Junta para tapón
hembra de gas 3/4*

*Joint pour bouchon 3/4
Gaz F.*

AR3F



**guarnizione per
tappo
1/2 F.**

Gasket for 1/2 F. Plug

*Уплотнительная
прокладка для
клапана 1/2 "мама"*

*Junta para tapón
hembra de gas 1/2*

*Joint pour bouchon
1/2 F.*

C42B



**guarnizione OR
silicone 70SH
26,64x2,62**

*Silicone O-Ring
Gasket 70 SH
26.64x2.62*

*Уплотнение OR
силиконовое 70 SH
26,64x2,62*

*Junta tórica de
silicona 70 SH
26.64x2.62*

*Joint OR Silicone 70
SH 26,64x2,62*

C43

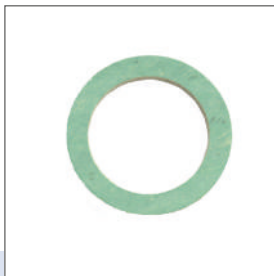

**guarnizione
racc. 3/8**

*Gasket for 3/8
Connector*

*Уплотнение для
разъема 3/8*

*Junta para conector
de 3/8*

Joint Racc. 3/8

R528



**ghiera ottone 3/4
Ø 35x5 mm**

*Brass Ring 3/4
Ø 35x5 mm*

*Латунное кольцо 3/4
Ø 35x5 mm*

*Anillo de latón 3/4
Ø.35x5 mm*

*Écrou en laiton 3/4
Ø 35x5 mm*

AR3M



**guarnizione per
tappo
3/8 M.**

Gasket for 3/8 M Plug

*Уплотнительная
прокладка для
клапана 3/8 "papa"*

*Junta para tapón
macho de 3/8*

*Joint pour bouchon
3/8 M.*

codici

Gasket for 3/4 Nozzle

Уплотнительная прокладка 3/4

guarnizione bocc. 3/4



C42

Junta para boquilla de 3/4

Joint pour embout 3/4

Teflon Gasket for 3/4 F. Plug

Уплотнительная прокладка для клапана 3/4 "мама" тефлон

guarnizione per tappo 3/4 teflon con foro



AR3T

Junta de teflón para tapón hembra de 3/4

Joint pour bouchon 3/4 F. Téflon

Gasket for 1/2 M Plug

Уплотнительная прокладка для клапана 1/2 "папа"

guarnizione per tappo 1/2 M.



AR44

Junta para tapón macho de 1/2

Joint pour bouchon 1/2 M.

brass safety valve c-10 3/8 m 12 bar

латунный предохранительный клапан c-10 3/8папа 12 бар

valvola di sicurezza ottone c-10 3/8M 12 bar



R707

válvula de seguridad c-10 3/8m 12 bar

souape de sécurité c-10 3/8m 12 bar

brass safety valve c-10 3/8 m 8 bar

латунный предохранительный клапан c-10 3/8папа 8 бар

valvola di sicurezza ottone c-10 3/8M 8 bar



R709

válvula de seguridad c-10 3/8m 8 bar

souape de sécurité c-10 3/8m 8 bar

saftey valve 1/8m 8 bar

клапан безопасности 1/8 папа 8 бар

valvola di sicurezza 1/8M 8 bar



R710

válvula de seguridad 1/8 m 8 bar

souape de sécurité 1/8m 8 bar

codici

R712



**valvola sicurezza
1/8M 9 bar**

*safety valve 1/8m 9
bar*

*клапан
безопасности 1/8
папа 9 бар*

*válvula de seguridad
1/8 m 9 bar*

*souape de sécurité
1/8m 9 bar*

R701



**valvola di
sicurezza ottone
C10-3/8 10 bar**

*Brass safety valve
C10-3/8 10 bar*

*Латунный
предохранительный
клапан C10-3/8 10 бар*

*Válvula de seguridad
de latón C10-3/8 10
bar*

*Souape de sécurité
en laiton C10-3/8 10
bar*

COF5505



**OMEGA tappo
55,6X57 mm
inox**

*Omega cap 55.6x57
mm stainless steel*

*Крышка Omega
55,6x57 мм из
нержавеющей стали*

*Tapa Omega 55,6x57
mm de acero
inoxidable*

*Bouchon Omega
55,6x57 mm en acier
inoxidable*

manometri e rubinetti



pressure gauges and taps

manómetros y grifos

manomètres et robinets

манометры и краны

codici

CV4F



manometro 12 bar con flangia

Pressure Gauge 12 bar with flange

Манометр 12 бар с фланцем

Manómetro de presión 12 bar con brida

Manomètre 12 bar avec bride

CV126



manometro 10 bar con flangia

Pressure Gauge 10 bar with flange

Манометр 10 бар с фланцем

Manómetro de presión 10 bar con brida

Manomètre 10 bar Avec Bride

MV4



manometro 6 bar senza flangia

Pressure Gauge 6 bar Without Flange

Манометр 6 бар без фланца

Manómetro de presión 6 bar sin brida

Manomètre 6 bar Sans Bride

MV4F



manometro 6 bar con flangia

Pressure Gauge 6 bar with flange

Манометр 6 бар с фланцем

Manómetro de presión 6 bar con brida

Manomètre 6 bar Avec Bride

COD0016



manometro 16bar Ø 40 Attacco 1/8

Pressure Gauge 16 BAR Ø 40 1/8 Connection

Манометр 16 бар диаметром Ø 40 мм, 1/8

Manómetro de presión 16 bar Ø 40 Conexión 1/8

Manomètre 16 bar Ø 40 Attacco 1/8

COD0017



manometro 10 bar colorato con flangia

Colorful Pressure Gauge 10 bar with flange

Манометр 10 бар цветной с фланцем

Manómetro de presión 10 bar

Manomètre 10 bar Coloré Avec Bride

Mini Ball Valve MF 3/8

Кран шаровой
"nana"/"мама" 3/8**rubinetto
minisfera MF 3/8**

codici

R111

Válvula de bola mini
MF 3/8Robinet à boisseau
sphérique MF 3/8

Mini Ball Valve MF 1/4

Кран шаровой
"nana"/"мама" 1/4**rubinetto
minisfera MF 1/4**

R112

Válvula de bola mini
MF 1/4Robinet à boisseau
sphérique MF 1/4

Mini Ball Valve FF 3/8

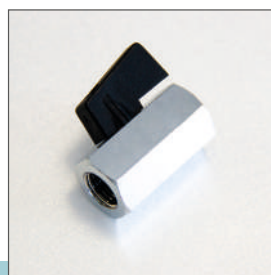
Кран шаровой
"мама"/"мама" 3/8**rubinetto
minisfera FF 3/8**

R113

Válvula de bola mini
FF 3/8Robinet à boisseau
sphérique FF 3/8Steam/Water
Regulation ValveКран регулировки
пара/воды**rubinetto
regolazione
vapore/acqua**

R121

Válvula reguladora de
vapor/aguaRobinet de réglage
vapeur/eauShort Spout Ball
Valve FF 1/4Кран иглово́й
"мама"/"мама" 1/4**rubinetto a spillo
FF 1/4**

R754

Válvula de bola de
pico corto FF 1/4Robinet à pointeau
FF 1/4Air Reduction/
Regulation 1/4FРедукция/
регулировка воздуха
1/4 "мама"**riduzione
regolazione aria
1-4 F**

R400

Reducción/regulación
de aire 1/4 hembraRéduction/Régulation
Air 1/4F

codici

RAC1001



**regolazione
detergente T 1/4
GF**

*Detergent Regulation
Valve T 1/4 GF*

*Регулятор моющего
средства T 1/4*

*Válvula de regulación
de detergente T 1/4
hembra*

*Régulation Détergent
T 1/4 GF*

COB3111



**rubinetto
minisfera MF3/8
FORATO con
coppiglia**

*Perforated Mini Ball
Valve MF 3/8 with Pin*

*Кран шаровой
"папа"/"мама"
3/8 с отверстием*

*Válvula de bola mini
perforada MF 3/8 con
pasador*

*Robinet à boisseau
sphérique MF 3/8
AVEC TROU C/*

R755A



**rubinetto a spillo
corto viton FF 1/4
- BF4000 ACQUA**

*Short Viton Spout FF
1/4 - BF4000 WATER*

*Кран игловой
короткий витон
"мама"/"мама" 1/4 -*

*Pico de Viton corto FF
1/4 - BF4000 AGUA*

*Robinet à pointeau
court en viton FF 1/4 -
BF4000 EAU*

R755A_1



**spillo corto viton
FF 1/4 - BF4000
ACQUA**

*Short Viton Spout FF
1/4 - BF4000 WATER*

*Игла короткая
витон
"мама"/"мама" 1/4 -*

*Pico de Viton corto FF
1/4 - BF4000 AGUA*

*Pointeau court en
viton FF 1/4 - BF4000
EAU*

R755_2

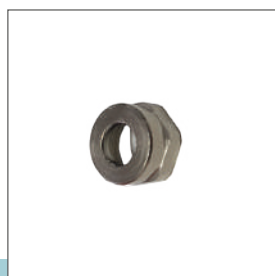

**ghiera rubinetto
BF4000**

Valve Nut - BF4000

Гайка крана - BF4000

*Tuerca de válvula -
BF4000*

*Écrou de robinet -
BF4000*

R754_2



**ghiera rubinetto
472-473-474 1/8
1/4 NIC spillo
lungo**

*Nut for Valves 472-
473-474 1/8 1/4 NIC
long spout*

*Гайка крана 472-
473-474 1/8 1/4 НИК с
длинной иглой*

*Tuerca para válvulas
472-473-474 1/8 1/4
pico largo NIC*

*Écrou de robinet 472-
473-474 1/8 1/4 NIC
pointeau long*

Long Spout + Viton OR 1/8-1/4
Длинная игла + OR витон 1/8-1/4

spillo lungo + OR viton 1/8-1/4



codici

R754_1

Pico largo + OR de Viton 1/8-1/4
Pointeau long + OR viton 1/8-1/4

Short Viton Spout FF 1/4 - BF4000 STEAM
Игла короткая витон "мама"/"мама" 1/4 - BF4000 пар

spillo corto FF 1/4 BF4000 VAPORE



R755_1

Pico de Viton corto FF 1/4 - BF4000 VAPOR
Pointeau court en viton FF 1/4 - BF4000 vapeur

Short Viton Spout FF 1/4 - BF4000 STEAM
Кран с иглой короткий витон "мама"/"мама" 1/4 - BF4000 пар

rubinetto a spillo corto FF 1/4 BF4000 VAPORE



R755

Pico de Viton corto FF 1/4 - BF4000 VAPOR
Robinet à pointeau court en viton FF 1/4 - BF4000 vapeur

Viton OR d.02.57-01.78 Spout 1/8 ¼
OR. д.02,57-01,78 Витон Игла 1/8 ¼

OR Ø 02,57-01,78 mm viton spillo 1/4-1/8



COD0507

OR de Viton d.02.57-01.78 Pico 1/8 ¼
Viton Pointeau 1/8 ¼

Viton FDA Sub. OR d.07.66-01.78 1/8
OR. д.07,66-01,78 Витон FDA 1/8

OR Ø 07,66-01,78 mm viton FDA sott. 1/8



COD0508

OR de Viton FDA d.07.66-01.78 1/8
Viton FDA Sott. 1/8

Black M8 Pass-Through Knob with Worked Design
Черная рукоятка M8 с отверстием

volantino M8 nero passante lavorato



COP0027

Perilla pasante M8 negra con diseño trabajado
Volant M8 noir traversant travaillé

codici

R604



**capillare rame manom.
250 mm
1/4M 1/8F**

*small copper hose for
pressure gauge
250 mm 1/4M 1/8F*

*Медный капилляр
для манометра 250
мм 1/4M 1/8F*

*capilar de cobre para
manómetro 250 mm
1/4M 1/8H*

*capillaire cuivre
manometre 250mm
1/4M 1/8F*

R604C



**capillare rame manom.
500 mm
1/4M 1/8F**

*small copper hose for
pressure gauge
500 mm 1/4M 1/8F*

*Медный капилляр
для манометра
500 мм 1/4M 1/8F*

*capilar de cobre para
manómetro 500 mm
1/4M 1/8H*

*capillaire cuivre
manometre 500 mm
1/4M 1/8F*

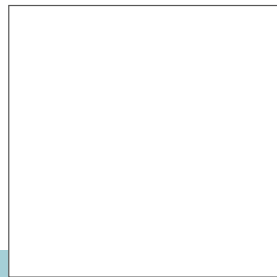

tubi di ricarica e taniche



refilling tubes and tanks

tubos de recarga y tanques

tubes de remplissage et jerrican

заборные шланги и канистры

codici

EM50A



**tubo ricarica
EMILIO RA**

*Loading hose EMILIO
RA*

*Шланг для подачи
воды в бойлер
EMILIO RA*

*Tubo de recarga
EMILIO RA*

*Tuyau de recharge
EMILIO RA*

CW55



**tubo ricarica
CARWASH**

*Loading hose
CARWASH*

*Шланг для подачи
воды в бойлер
CARWASH*

*Tubo de recarga
CARWASH*

*Tuyau de recharge
CARWASH*

CW55B



**tubo ricarica
detergente
CARWASH**

*Loading hose
CARWASH Detergent*

*Шланг для подачи
моющего средства
CARWASH*

*Tubo de recarga
Detergente
CARWASH*

*Tuyau de recharge
détergent CARWASH*

CV112



**tubo ricarica
caldaia
CLEAN VAPOR**

*Loading hose CLEAN
VAPOR Boiler*

*Шланг для подачи
воды в бойлер CLEAN
VAPOR*

*Tubo de recarga
Caldera CLEAN
VAPOR*

*Tuyau de recharge
chaudière CLEAN
VAPOR*

CV112A



**tubo ricarica
detergente
CLEAN VAPOR**

*Loading hose CLEAN
VAPOR Detergent*

*Шланг для подачи
моющего средства
CLEAN VAPOR*

*Tubo de recarga
Detergente CLEAN
VAPOR*

*Tuyau de recharge
détergent CLEAN
VAPOR*

CV112B



**tubo ricarica
caldaia CLEAN
VAPOR JR/
VAPOBUS**

*Loading hose CLEAN
VAPOR Jr/VAPOBUS
Boiler*

*Шланг для подачи
воды в бойлер CLEAN
VAPOR Jr/VAPOBUS*

*Tubo de recarga
Caldera CLEAN
VAPOR Jr/VAPOBUS*

*Tuyau de recharge
chaudière CLEAN
VAPOR Jr/VAPOBUS*

Loading hose CLEAN VAPOR Jr/VAPOBUS Detergent

Шланг для подачи моющего средства CLEAN VAPOR Jr/VAPOBUS

**tubo ricarica
detergente
CLEAN VAPOR JR/
VAPOBUS**



codici

CV112C

Tube de recarga Detergente CLEAN VAPOR Jr/VAPOBUS

Tuyau de recharge détergent CLEAN VAPOR Jr/VAPOBUS

Loading hose VAPORDENT

Шланг для подачи воды в бойлер VAPORDENT

**tubo ricarica
VAPORDENT**

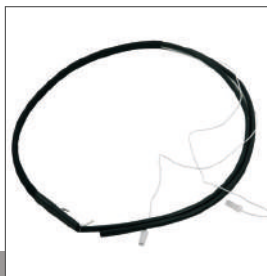

CV112D

Tube de recarga VAPORDENT

Tuyau de recharge VAPORDENT

Loading hose ECOWASH

Шланг для подачи воды в бойлер ECOWASH

**tubo ricarica
ECOWASH**

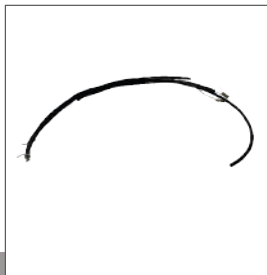

CV112E

Tube de recarga ECOWASH

Tuyau de recharge ECOWASH

Loading hose ECOWASH Detergent

Шланг для подачи моющего средства ECOWASH

**tubo ricarica
ECOWASH
detergente**

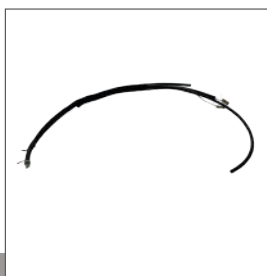

CV112F

Tube de recarga Detergente ECOWASH

Tuyau de recharge détergent ECOWASH

Loading hose AUTOMATIC VAPOR

Шланг для подачи воды в бойлер AUTOMATIC VAPOR

**tubo ricarica
AUTOMATIC
VAPOR**



AVS

Tube de recarga Caldera AUTOMATIC VAPOR

Tuyau de recharge AUTOMATIC VAPOR

Loading hose FOREVER RA

Шланг для подачи воды в бойлер FOREVER RA

**tubo ricarica
FOREVER RA**



TA114

Tube de recarga Caldera FOREVER RA

Tuyau de recharge FOREVER RA

codici

MG112



**tubo ricarica
MAGIC RA**

*Loading hose Magic
RA*

*Шланг для подачи
воды в бойлер
MAGIC RA*

*Tubo de recarga
Caldera Magic RA*

*Tuyau de recharge
Magic RA*

EM50B



**tubo ricarica
detergente
EMILIO**

*Loading hose Emilio
Detergent*

*Шланг для подачи
моющего средства
EMILIO*

*Tubo de recarga
Detergente Emilio*

*Tuyau de recharge
détergent Emilio*

COP2003

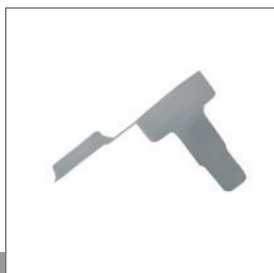

**filtrino tubo
ricarica**

Refill Tube Filter

*Фильтр для
заборного шланга*

Tubo de recarga Filtro

*Filtrino Tuyau de
recharge*

3-liter Tank Magic Vapor RA

Канистра 3 л Magic Vapor RA

tanica 3 lt MAGIC VAPOR RA



codici

COD0402

Tanque de 3 litros Magic Vapor RA

Jerrican de 3 litres Magic Vapor RA

5-liter Tank with Cap

Канистра 5 л с крышкой

tanica 5 lt con tappo



COD0405

Tanque de 5 litros con tapa

Jerrican de 5 litres avec bouchon

10-liter Tank with Cap

Канистра 10 л с крышкой

tanica 10 lt c/tappo



COD0401

Tanque de 10 litros con tapa

Jerrican de 10 litres avec bouchon

20-liter Tank

Канистра 20 л

tanica 20 lt



C235

Tanque de 20 litros

Jerrican de 20 litres

Zip Emilio Tank

Канистра Zip Emilio

tanica zip EMILIO



EMA

Tanque Zip Emilio

Jerrican Zip Emilio

codici

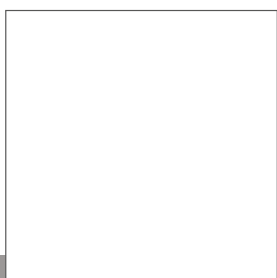
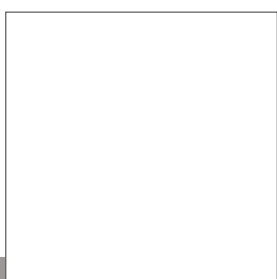
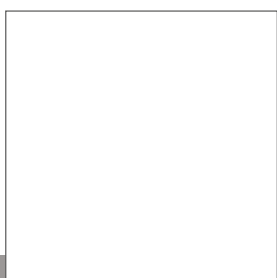
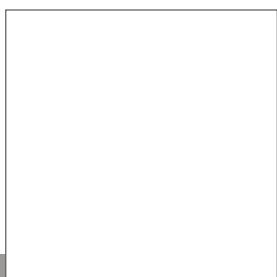
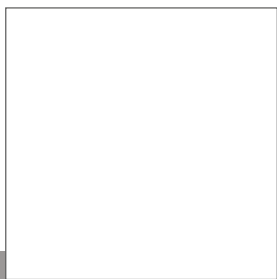
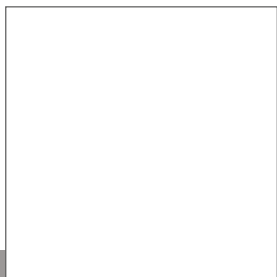

**pompe, valvole
e connessi**



pumps, valves and fittings

bombas, valvulas y conexiones

pompes, robinets et raccords

насосы, клапаны, фитинги

codici

AV10C



**supporto
antivibrante
pompa gomma**

*Rubber Pump
Antivibration Support*

*Крепление
антивибрационное
резиновое для
насоса*

*Soporte antivibración
de bomba de goma*

*Support Antivibratoire
pour Pompe en
Caoutchouc*

AV10E



**supporto pompa
60x58x47 mm**

*Pump Support
60x58xH47mm*

*Крепление для
насоса 60x58xH47
мм*

*Soporte de bomba
60x58xH47mm*

*Support de Pompe
60x58xH47mm*

COE5002



**pompa OT 150
I/HBY PASS
NORMALE 15 bar
ARIASANA**

*Pump OT 150 L/H
Bypass Normal
15.0 BAR BF4000 /
ARIASANA*

*Насос OT 150 л/ч с
обходным клапаном,
15,0 Бар BF4000 /
ARIASANA*

*Bomba OT 150 L/H
Bypass Normal
15.0 BAR BF4000 /
ARIASANA*

*Pompe OT 150 L/H
Bypass Normale
15,0 BAR BF4000 /
ARIASANA*

COE2401

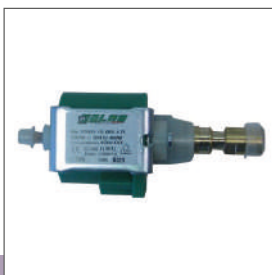

**pompa vibrante
(EX5) 15 bar 230V
OLAB completa**

*Vibrating Pump (EX5)
15.0 BAR 230V OLAB
Complete*

*Вибрационный насос
(EX5) 15,0 Бар 230 В
OLAB, в сборе*

*Bomba vibrante (EX5)
15.0 BAR 230V OLAB
Completa*

*Pompe Vibrante (EX5)
15,0 BAR 230V OLAB
Complète*

COE2402

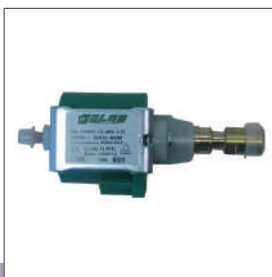

**pompa vibrante
(EX7) 7 bar 230V
OLAB completa**

*Vibrating Pump (EX7)
7.0 BAR 230V OLAB
Complete*

*Вибрационный насос
(EX7) 7,0 Бар 230 В
OLAB, в сборе*

*Bomba vibrante (EX7)
7.0 BAR 230V OLAB
Completa*

*Pompe Vibrante (EX7)
7,0 BAR 230V OLAB
Complète*

COE2460



**pompa Pedrollo
PQM81 1/2
uscita lato**

*Pedrollo Pump
PQM81 1/2 Side
Outlet*

*Насос Pedrollo PQM81
1/2 с выходом на
стороне*

*Bomba Pedrollo
PQM81 1/2 con salida
lateral*

*Pompe Pedrollo
PQM81 1/2 Sortie Côté*

Pump with 220V Motor 150 L/H Bypass Normal 15,0 BAR
Bomba con motor de 220V 150 L/H Bypass Normal 15,0 BAR

Насос с двигателем 220 В, 150 л/ч, с обходным клапаном, 15,0 Бар
Pompe Avec Moteur 220V 150 L/H Bypass Normale 15,0 BAR

**pompa motore
220V 150 L/H
bypass normale
15,0 BAR**

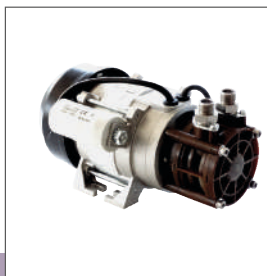

codici

COE2462

Vibrating Pump (EX5) 15 BAR 120V CEME Complete
Bomba vibrante (EX5) 15 BAR 120V CEME Completa

Вибрационный насос (EX5) 15 Бар 120 В CEME, в сборе
TPompe Vibrante (EX5) 15 BAR 120V CEME Complète

**pompa vibrante
15 bar 120V CEME
completa**



COE2416

pump NME4V 230v w/viton antivib.
bomba ulka NME4V 230v c/viton y antivibrantes

насос NME4V 230v с витон и антивибрацией
pompe NME4V 230v a/viton antivib

**pompa NME4V
230V con VITON e
antivibranti**



COE2452

NME4 230V ULKA Pump with Antivibrants
Bomba ULKA NME4 230V con antivibrantes

Насос NME4 230 В ULKA с антивибрацией
Pompe NME4 230V ULKA C/Antivibrants

**pompa NME4
230V ULKA con
antivibranti**



COE2454

Pump Thermal Protector 110°C OLAB/ULKA
Protector térmico para bomba 110°C OLAB/ULKA

Термозащита насоса 110 °C OLAB /ULKA
Thermodétecteur de Pompe 110°C OLAB/ ULKA

**termoprotettore
pompa 110°C
OLAB/ULKA**

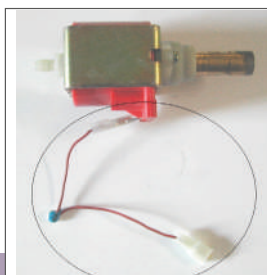

AV10A

Self-priming Brass Pump Valve
Válvula de bomba de latón autocebante

Клапан автозагрузки насоса из латуни
Souape d'Auto- amorçage en Laiton pour Pompe

**valvola
autoinnesco
pompa in ottone**



COE2413

codici

CV63



valvola autoinnesco pompa in plastica

Self-priming Plastic Pump Valve

Клапан автозагрузки насоса из пластика

Válvula de bomba de plástico autocebante

Souape d'Auto-amorçage en Plastique pour Pompe

R751



valvola sfera deviatrice 1/4 3 vie 2011

3-Way Ball Diverter Valve 1/4 3 Way 2011

Шаровой клапан 3-х позиционный 1/4 3 выхода 2011

Válvula de desvío de bola de 3 vías 1/4 3 vías 2011

Vanne à Bille Déviatrice 1/4 3 Voies 2011

RIS5101



valvola vapore meccanica per presse 498 mm 3/4 Ø 27 mm

Mechanical Steam Valve for Presses 498mm 3/4 d.27

Механический клапан пара для прессы, 498 мм, 3/4

Válvula mecánica de vapor para prensas 498 mm 3/4 d.27

Souape à Vapeur Mécanique Pour Presses 498mm 3/4

R706



valvola di ritegno EUROPA 1/2 F

Europa Non-Return Valve 1/2 F.

Обратный клапан Европа 1/2 F

Válvula de retención Europa 1/2 hembra

Souape de Rétention Europa 1/2 F.

CW40



valvola vapore con portagama contrapposti

Steam Valve with Opposed Gamma Port

Паровой клапан с противоположной насадкой для шланга

Válvula de vapor con puerto gamma opuesto

Souape à Vapeur Avec Porte-écran Contrapposti

CW40A



valvola vapore con portagama paralleli

Steam Valve with Parallel Gamma Port

Паровой клапан с параллельной насадкой для шланга

Válvula de vapor con puerto gamma paralelo

Souape à Vapeur Avec Porte-écran Paralleli

Bidirectional Valve
Bieffe 1/4m

Перепускной клапан
Bieffe 1/4 "mama"

**valvola
bidirezionale
BIEFFE 1/4 H**



codici

CV60B

Válvula bidireccional
Bieffe 1/4 macho

Souape
Bidirectionnelle Bieffe
1/4m

Non-Return Valve
1/4F 1/4F

Клапан обратного
потока 1/4 "мама"
1/4 "мама"

**valvola non
ritorno 1/4 F 1/4
F**



RAC1002

Válvula de retención
1/4 hembra 1/4
hembra

Souape de Non-
retour 1/4F 1/4F

Water Filter 1/2 BSP
F-1/2 BSP F

Фильтр воды 1/2
BSP F-1/2 BSP F

**filtro acqua 1-2
bsp f-1-2 f**



RAC1003

Filtro de agua 1/2 BSP
hembra - 1/2 BSP
hembra

Filtre à Eau 1/2 BSP
F-1/2 BSP F

Float Series 21

Поплавок Серия 21

**galleggiante
serie 21**



AR128

Flotador Serie 21

Flotteur Série 21

Anti-vibration
micropump NME

Антивибрационный
микронасос NME

**antivibrante
micropompe
NME**



COE2457

Microbomba
antivibración NME

Micropompe
antivibratoire NME

codici

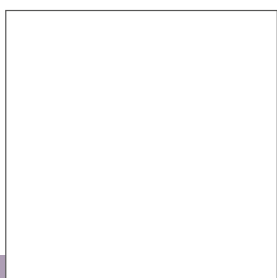
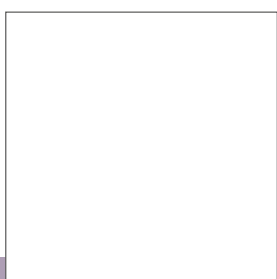
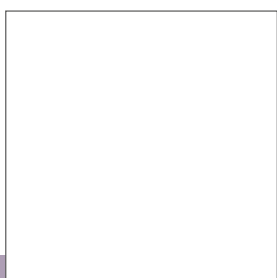
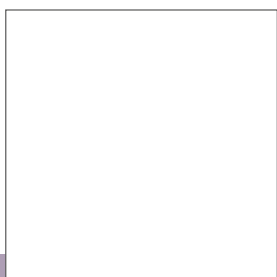
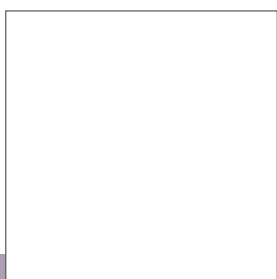
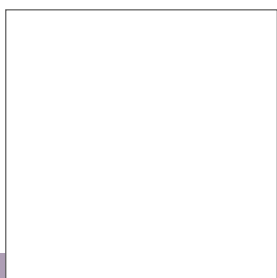

**schede,
componenti elettrici,
interruttori**



**electrical boards and components,
switches**

**tarjetas electricas,
componentes electricos,
interruptores**

**cartes et composants electriques,
interrupteurs**

**электронные платы,
электрические компоненты,
переключатели**

codici

COE2155



**scheda controllo
acqua macchine
resistenza
interna 220V**

*Water Control Board
for Machines Internal
Resistance 220V*

*Электронная плата
контроля воды для
машин с внутр.
нагрев. элемент.
220 В*

*Tablero de control
de agua para
resistencias internas
de máquinas 220V*

*Carte de contrôle
d'eau pour machines,
résistance interne
220V*

CV53



**scheda controllo
presenza acqua
220V 70x103 mm**

*Water Presence
Control Board 220V
70x103 mm*

*Электронная плата
контроля наличия
воды 220 В, 70x103 мм*

*Tablero de control
de presencia de agua
220V 70x103 mm*

*Carte de contrôle de
présence d'eau 220V
70x103 mm*

CV53R



**scheda controllo
acqua 220V 1
rele' 70x103 mm**

*Water Control Board
220V 1 Relay
70x103 mm*

*Электронная плата
контроля воды 220
В, 1 реле, 70x103 мм*

*Tablero de control
de agua 220V 1 relé
70x103 mm*

*Carte de contrôle
d'eau 220V avec 1
relais 70x103 mm*

CV54

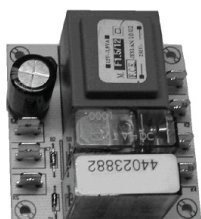

**scheda piccola
alimentazione
220V 2 rele' 12V**

*Small Power Supply
Board 220V 2 Relays
12V*

*Электронная плата
маленькая контроля
питания 220 В, 2 реле,
12 В*

*Placa de alimentación
pequeña 220V 2 relés
12V*

*Petite carte
d'alimentation 220V
avec 2 relais 12V*

CV54/1



**scheda piccola
alimentazione
220V 1 rele' 12V**

*Small Power Supply
Board 220V 1 Relay
12V*

*Электронная плата
маленькая контроля
питания 220 В, 1 реле,
12 В*

*Placa de alimentación
pequeña 220V 1 relé
12V*

*Petite carte
d'alimentation 220V
avec 1 relais 12V*

CV54/3

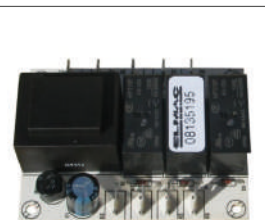

**scheda piccola
alimentazione
220V 3 rele' 12V**

*Small Power Supply
Board 220V 3 Relays
12V*

*Электронная плата
маленькая контроля
питания 220 В, 3
реле, 12 В*

*Placa de alimentación
pequeña 220V 3 relés
12V*

*Petite carte
d'alimentation 220V
avec 3 relais 12V*

Board Charging Case
78x111 mm

Корпус для
электронной платы
78x111 мм

custodia scheda
ricarica
78x111 mm



codici

CV81

Caja de carga de la
placa 78x111 mm

Boîtier pour carte de
recharge 78x111 mm

Board Case with
Relays

Корпус для платы
с реле

custodia schede
e rele'



CV90

Caja de la placa con
relés

Boîtier pour cartes
plus relais

3x20A 0/1/2 Bremas
Changeover Switch

Переключатель
соединитель 3x20A
0/1/2 Bremas

interruttore
commutatore
3x20A 0/1/2
Bremas



CW24D

Interruptor
comutador 3x20A
0/1/2 Bremas

Interrupteur
commutateur 3x20A
0/1/2 Bremas

2x25A 0/1
Changeover Switch

Переключатель
соединитель 2x25A
0/1

interruttore
commutatore
2x25A 0/1



COE3024

Interruptor
comutador 2x25A
0/1

Interrupteur
commutateur 2x25A
0/1

Switch Cap and
Frame

Крышка и рамка для
переключателя

cappuccio e
cornice per
interruttore



BV4C

Capuchón y marco del
interruptor

Capuchon et cadre
pour interrupteur

Green Fluorescent
Indicator Light 230V -
BV5EM

Зеленый световой
индикатор 230 В

segnalatore
luminoso verde
fluoro 230V



BV5EM

Indicador luminoso
verde fluorescente
230V - BV5EM

Indicateur lumineux
vert 230V - BV5EM

codici

COE3006



**pulsante
bipolare aperto
bianco**

*Bipolar White Open
Button*

*Белая биполярная
кнопка*

*Botón abierto bipolar
blanco*

*Bouton-poussoir
bipolaire ouvert blanc*

CW24H

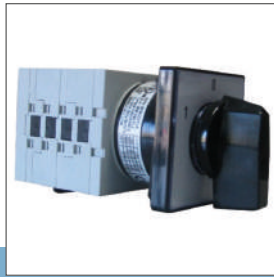

**interruttore
commutatore
4x20A 1/0/2**

*4x20A 1/0/2
Changeover Switch*

*Переключатель
соединитель 4x20A
1/0/2*

*Interruptor
conmutador 4x20A
1/0/2*

*Interrupteur
commutateur 4x20A
1/0/2*

COE3031



**interruttore nero
Uni.
Term 2,8
13x19 mm**

*Black switch Uni.
Term. 2,8 13x19 mm*

*Переключатель
черный 2,8
13x19*

*Interruptor negro Uni.
Term. 2.8 13x19 mm*

*Interrupteur noir
universel à bornes 2,8
13x19 mm*

CV4I



**interruttore rosso
con protezione**

*Red Switch with
Protection*

*Переключатель
красный с защитой*

*Interruptor rojo con
protección*

*Interrupteur rouge
avec protection*

BV4



**interruttore
rosso basculante
I/O 16A**

*Red Toggle Switch I/O
16A*

*Переключатель
красный I/O 16A*

*Interruptor
basculante rojo I/O
16A*

*Interrupteur basculant
rouge I/O 16A*

4.018.07.
001SP



**interruttore
chiave estr. 0
C.U. KSO SC**

*o C.U. KSO SC Key
Extractor Switch*

*Переключатель
ключ o C.U. KSO SC*

*Interruptor de
extracción de llave o
C.U. KSO SC*

*interrupteur à clé estr.
o C.U. KSO SC*

Micro Steam Gun *Микропереключатель для парового пистолета*

micro pistola vapore



codici

AR25M

Pistola de vapor Micro *Micro pistolet à vapeur*

Black Button 19x13 mm *Кнопка черная 19x13 mm*

pulsante nero 19x13 mm



COE3042

Botón negro 19x13 mm *Bouton noir 19x13 mm*

Power Relay Finder 20A 220V AC *Реле электрическое Finder 20A 220 B*

rele' di potenza finder 20A 220V AC



C64

Relé de potencia Finder 20A 220V AC *Relais de puissance Finder 20A 220V AC*

Complete Digital Timer Black *Таймер черный в сборе*

temporizzatore completo digitale nero



SX08D

Temporizador digital completo negro *Minuterie digitale complète noire*

MIKA Capacitor 2.5 YF 450V 25x50 Pin *Конденсатор MIKA 2,5 YF 450V 25x50*

condensatore MIKA 2,5 YF 450V 25x50 mm codolo



COE4014

Capacitor MIKA 2.5 YF 450V 25x50 Pin *Condensateur MIKA 2,5 YF 450V 25x50 avec cosse*

Micro Footswitch without Lever 5A *Микропереключатель для педали 5A без рычага*

micropedaliera s/leva 5A



COE3101

Pedal micro sin palanca 5A *Micro pédale sans levier 5A*

codici

BV5



segnalatore luminoso rosso 13x32 mm

Red Indicator Light 13x32 mm

Красный световой индикатор 13x32 mm

Indicador luminoso rojo 13x32 mm

Indicateur lumineux rouge 13x32 mm

BV5T



segnalatore luminoso rosso 22x30 mm

Red Indicator Light 22x30 mm

Красный световой индикатор 22x30 mm

Indicador luminoso rojo 22x30 mm

Indicateur lumineux rouge 22x30 mm

COE3007



deviatore bipolare verde I/II 22x30 mm

Green Bipolar Selector Switch I/II 22x30 mm

Зеленый двухполюсный переключатель I/II 22x30 mm

Interruptor selector bipolar verde I/II 22x30 mm

Interrupteur bipolaire vert I/II 22x30 mm d.27

COE0201



presa Italia 12x26 mm 2P+T 10A/250V nera

Italy Socket 12x26 2P+T 10A/250V Black

Розетка "Италия" 12x26 2P+T 10A/250V черная

Toma de corriente italiana 12x26 2P+T 10A/250V negro

Prise italienne 12x26 2P+T 10A/250V noire

COE0202



presa quadra nera

Black Square Socket 10-16/250V

Розетка квадратная черная 10-16/250V

Toma de corriente cuadrada negra 10-16/250V

Prise carrée noire 10-16/250V

COE3052



Contattore 4NO 230V 40A (380V) ITALWEBER

Contactor 4NO 230V 40A (380V) ITALWEBER

Контактор 4NO 230V 40A (380V) ITALWEBER

Contactores 4NO 230V 40A (380V) ITALWEBER

Contacteur 4NO 230V 40A (380V) ITALWEBER

Contactore 2NO 230V
AC/DC 25A FINDER

Контактор 2NO
230V AC/DC 25A
FINDER

**Contattore 2NO
230V AC/DC 25A
FINDER**



codici

COE3051

Contactador 2NO
230V AC/DC 25A
FINDER

Contacteur 2NO 230V
AC/DC 25A FINDER

Inverter for BF4000
for Battery Use -
1500W 12V/220V

Инвертор для
BF4000 для
использования с
аккумулятором -
1500W 12V/220V

**inverter per
BIEFFE4000 per
uso con batteria
1500W 12V/220V**



COE4032

Inversor para BF4000
para uso con batería -
1500W 12V/220V

Convertisseur pour
BF4000 pour utilisation
avec batterie - 1500W
12V/220V

Inverter for BF4000
Vacuum for Battery
Use - 2000W
12V/220V

Инвертор для
BF4000 Vacuum для
использования с
аккумулятором -
2000W 12V/220V

**inverter per
BIEFFE4000
vacuum per uso
con batteria
2000W 12V/220V**



COE4033

Inversor para BF4000
Aspiradora para uso
con batería - 2000W
12V/220V

Convertisseur pour
BF4000 Aspirateur pour
utilisation avec batterie -
2000W 12V/220V

Timer complete 1
hour 2 poles

Таймер полный 1 час
2 полюса

**temporizzatore
completo
1 ora 2 poli**



COE4021

Temporizador
completo 1 hora 2
polos

Minuterie complète 1
heure 2 pôles

Complete 2-hour
Digital Timer G 2H 2C
5043 2-pole - COE4022

Таймер в сборе 2
часа G 2H 2C 5043,
2-х полюсный

**temporizzatore
completo 2 ore G
2H 2C 50 43 2 poli
AR25**



COE4022

Temporizador digital
completo de 2 horas
G 2H 2C 5043 2 polos
COE4022

Minuterie complète 2
heures G 2H 2C 5043 2
pôles - COE4022

Timer complete 2
hours DKJ/1 pole

Полный таймер 2
часа DKJ/1 полюс

**temporizzatore
completo
2 ore
dkj/1 polo**



COE4023

Timer complete 2
hours DKJ/1 pole

Minuterie complète 2
heures DKJ/1 pôle

codici

RIP6002

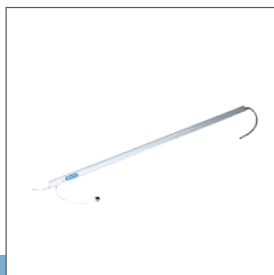

lampada led per interni auto 14W

Led Lamp for Car Interiors 14W

Лампа LED для внутреннего освещения автомобиля, 14 Вт

Lámpara LED para interiores de auto 14W

Lampe LED pour l'intérieur de voiture 14W

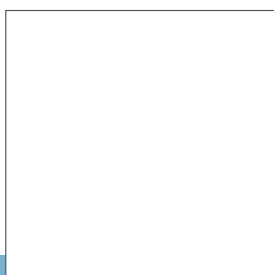
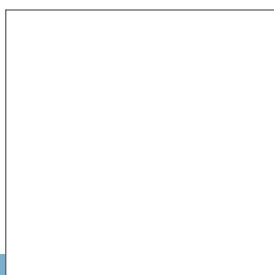
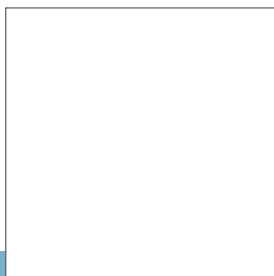

cavi di
alimentazione



power cables

cables de alimentacion

cables d'alimentation

кабели электропитания

codici

COE0017



cavo alimentazione 3x1,5 1,2 m spina tedesca

Power Cable 3x1.5 1.2 m German Plug

Кабель электропитания 3x1,5 1,2 м с европ. вилкой

Cable de alimentación 3x1.5 1.2 m con enchufe alemán

Câble d'alimentation 3x1,5 1,2m avec fiche allemande

COE0016



cavo alimentazione 3x1,5 2 m spina tedesca

Power Cable 3x1.5 2m German Plug

Кабель электропитания 3x1,5 2 м с европ. вилкой

Cable de alimentación 3x1.5 2 m con enchufe alemán

Câble d'alimentation 3x1,5 2m avec fiche allemande

COE0021



cavo alimentazione 3x1,5 400 cm spina tedesca

Power Cable 3x1.5 400cm German Plug

Кабель электропитания 3x1,5 400 см с европ. вилкой

Cable de alimentación 3x1.5 400 cm con enchufe alemán

Câble d'alimentation 3x1,5 400cm avec fiche allemande

C67



bloccacavo in plastica con vite

Plastic Cable Clamp with Screw

Пластиковый кабельный зажим с винтом

Abrazadera de cable de plástico con tornillo

Serre-câble en plastique avec vis

C11



bloccacavo in plastica sr 6n-4 nero

Plastic Cable Clamp SR 6N-4 Black

Пластиковый кабельный зажим SR 6N-4, черный

Abrazadera de cable de plástico SR 6N-4 negra

Serre-câble en plastique SR 6N-4 noir

AS20



bloccacavo piatto AR NY nero

Flat AR NY Black Cable Clamp

Плоский пластиковый кабельный зажим AR NY, черный

Contactores 4NO 230V 40A (380V) ITALWEBER

Serre-câble plat AR NY noir

**fascette e
raccordi**



BIEFFE®
FARINELLI
GENERATORI DI VAPORE

clamps and fittings

bridas y accesorios

colliers de serrage et raccords

хомуты и фитинги

codici

V701



**fascetta serrafili
nero 98x2,5 mm**

*Black Wire Clamp
98x2.5 mm*

*Черная кабельная
стяжка 98x2,5 мм*

*brazadera de cable
negra 98x2.5 mm*

*Attache-câble noir en
fil d'acier 98x2,5 mm*

V702



**fascetta serrafili
nero
160x4,5 mm**

*Black Wire Clamp
16x4.5 mm*

*Черная кабельная
стяжка 16x4,5 мм*

*Abrazadera de cable
negra 16x4.5 mm*

*Attache-câble noir en
fil d'acier 16x4,5 mm*

V521



**fascetta metallo
11-14 mm scatto**

*Metal Clamp 11-14
Snap*

*Металлический
хомут 11-14 с
фиксатором*

*Abrazadera metálica
11-14 de presión*

*Attache en métal 11-
14 à cliquet*

V522



**fascetta metallo
10-12 mm con
vite**

*Metal Clamp 10-12
with Screw*

*Металлический
хомут 10-12
винтовой*

*Abrazadera metálica
10-12 con tornillo*

*Attache en métal 10-
12 avec vis*

V524



**fascetta metallo
15-17 mm con
vite**

*Metal Clamp 15-17
with Screw*

*Металлический
хомут 15-17
винтовой*

*Abrazadera metálica
15-17 con tornillo*

*Attache en métal 15-
17 avec vis*

V501



**fascetta
antigrinza
11,5 mm zincata**

*Galvanized Anti-seize
Clamp 11.5*

*Антикоррозийный
хомут 11,5,
оцинкованный*

*Abrazadera
antiadherente
galvanizada 11.5*

*Attache anti-fuite
galvanisée 11,5*

codici

Galvanized Anti-seize Clamp 12.5 Анतिकоррозионный хомут 12,5, оцинкованный

fascetta antigrinza 12,5 mm zincata



V502

Abrazadera antiadherente galvanizada 12.5 Attache anti-fuite galvanisée 12,5

Galvanized Anti-seize Clamp 10.5 Анतिकоррозионный хомут 10,5, оцинкованный

fascetta antigrinza 10,5 mm zincata



V503

Abrazadera antiadherente galvanizada 10.5 Attache anti-fuite galvanisée 10,5

Anti-seize Clamp 8.5 Анतिकоррозионный хомут 8,5

fascetta antigrinza 8,5 m zincata



V516

Abrazadera antiadherente 8.5 Attache anti-fuite 8,5

Conical Reducing Fitting 3/8M 1/4F Переходник редукционный коническая резьба 3/8 "nana" 1/4

raccordo riduzione conica 3/8M 1/4F



R021

Accesorio reductor cónico 3/8M 1/4H Raccord conique réducteur 3/8M 1/4F

Conical Nipple Fitting 1/4M 1/4M Переходник ниппельный коническая резьба 1/4 "nana" 1/4 "nana"

raccordo nippolo conico 1/4M 1/4M



R031

Accesorio de tetón cónico 1/4M 1/4M Raccord tamelon conique 1/4M 1/4M

Conical Nipple Fitting 1/8M 1/4M Переходник ниппельный коническая резьба 1/8 "nana" 1/4 "nana"

raccordo nippolo conico 1/8M 1/4M



R033

Accesorio de tetón cónico 1/8M 1/4M Raccord tamelon conique 1/8M 1/4M

codici

R055B



**raccordo OGIVA A
LM 1/4M**

OGIVE Fitting L 1/4M

*Переходник
нипельный
коническая резьба L
1/4 "пана"*

*Accesorio de ojiva L
1/4M*

*Raccord OGIVA L
1/4M*

R061



**raccordo calz.dir.
cilindrico 3/8M
8-6**

*Straight Cylindrical
Compression Fitting
3/8M 8-6*

*Прямой штуцер
3/8M 8-6*

*Accesorio de
compresión cilíndrico
recto 3/8M 8-6*

*Raccord à
emmanchement droit
3/8M 8-6*

R062



**raccordo calz.dir.
cilindrico 1/8M
8-6**

*Straight Cylindrical
Compression Fitting
1/8M 8-6*

*Прямой штуцер
1/8M 8-6*

*Accesorio de
compresión cilíndrico
recto 1/8M 8-6*

*Raccord à
emmanchement droit
1/8M 8-6*

R063

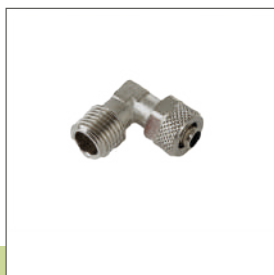

**raccordo calz. I
cilindrico 1/4M
8-6**

*Straight Cylindrical
Compression Fitting
1/4M 8-6*

*L-образный штуцер
1/4M 8-6*

*Accesorio de
compresión cilíndrico
recto 1/4M 8-6*

*Raccord à
emmanchement droit
1/4M 8-6*

R064



**raccordo calz.dir.
cilindrico 1/4M
8-6**

*Straight Cylindrical
Compression Fitting
1/4M 8-6*

*Прямой штуцер 1/4M
8-6*

*Accesorio de
compresión cilíndrico
recto 1/4M 8-6*

*Raccord à
emmanchement droit
1/4M 8-6*

R065



**raccordo calz. I
cilindrico 1/8M
8-6**

*Straight Cylindrical
Compression Fitting
1/8M 8-6*

*L-образный штуцер
1/8M 8-6*

*Accesorio de
compresión cilíndrico
recto 1/8M 8-6*

*Raccord à
emmanchement droit
1/8M 8-6*

codici

T Fitting MFF 1/8

T-образный
переходник "папа"
"мама" "мама" 1/8

**raccordo T MFF
1/8**



R001

Accesorio de T MHH
1/8

Raccord en T MFF 1/8

T Fitting FFF 1/4

T-образный
переходник "мама"
"мама" "мама" 1/4

**raccordo T FFF
1/4**



R004

Accesorio de T
HHH 1/4

Raccord en T FFF 1/4

L Fitting M1/8 F1/4

T-образный
переходник L
"папа" 1/8 "мама" 1/4

**raccordo
L M 1/8
F 1/4**



R016

Accesorio de L M1/8
H1/4

Raccord en L M1/8
F1/4

Male Hose Nipple
1/4 7

Штуцер
гофрированный
"папа" 1/4 7

**portagomma
maschio 1/4 7**



R011

Niple macho para
manguera 1/4 7

Porte-tuyau mâle en
laiton 1/4 7

Brass Hose Nipple
ES.13 Male 1/4 7.5

Штуцер
гофрированный из
латуни "папа" ES.13
1/4 7,5

**portagomma
ottone es.13
maschio 1/4
7,5**



R011T

Niple macho de latón
ES.13 1/4 7.5

Porte-tuyau en laiton
ES.13 mâle 1/4 7,5

Brass Hose Nipple
ES.13 Male 1/8 7.5

Штуцер
гофрированный из
латуни "папа" ES.13
1/8 7,5

**portagomma
ottone es.13
maschio 1/8
7,5**



R012T

Niple macho de latón
ES.13 1/8 7.5

Porte-tuyau en laiton
ES.13 mâle 1/8 7,5

codici

R518



**dado ottone e.
30x12 mm 3-4F**

*Brass Nut E.30X12
mm 3/4F*

*Гайка латунная
E.30X12 мм 3/4
"мама"*

*Tuerca de latón
E.30X12 mm 3/4H*

*Écrou en laiton
E.30X12 mm 3/4F*

R535



**perno ottone Ø
30x40 mm**

*Brass Pin Ø 30x40
mm*

*Штуцер латунный
Ø 30x40 mm*

*Pasador de latón Ø
30x40 mm*

*Boulon en laiton Ø
30x40 mm*

R536



**dado ottone e.
30x12 mm
M24x15**

*Brass Nut E. 30X12
mm M24X15*

*Гайка латунная E.
30X12 мм M24X15*

*Tuerca de latón E.
30X12 mm M24X15*

*Écrou en laiton E.
30X12 mm M24X15*

R564

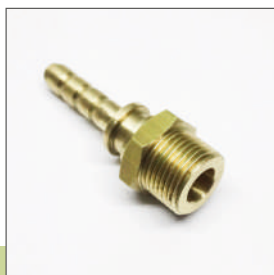

**raccordo ottone
53 mm PG
Ø 6,5 mm**

*Brass Fitting 53 mm
PG Ø 6.5mm*

*Штуцер латунный
53 мм PG Ø 6,5 мм*

*Accesorio de 53 mm
PG Ø 6.5 mm*

*Raccord en laiton 53
mm PG Ø 6,5 mm*

R064



**raccordo ottone
57 mm PG
Ø 6,5 mm**

*Brass Fitting 57 mm
PG Ø 6.5mm*

*Штуцер латунный
57 мм PG Ø 6,5 мм*

*Accesorio de 57 mm
PG Ø 6.5 mm*

*Raccord en laiton 57
mm PG Ø 6,5mm*

R565

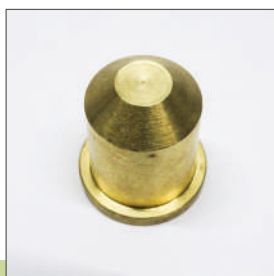

**tappo di ottone
24 mm
Ø 22 mm**

*Brass Cap 24 mm Ø
22 mm*

*Пробка медная 24 мм
Ø 22 мм*

*Tapa de latón de 24
mm Ø 22 mm*

*Bouchon en laiton 24
mm Ø 22 mm*

Brass Fitting Ø 13x29
mm

Штуцер латунный
Ø.13x29 mm

**raccordo ottone
Ø 13x29 mm**



codici

R629

Accesorio de Ø 13x29
mm de latón

Raccord en laiton Ø
13x29 mm

Brass Fitting Ø 30x20
mm with collar

Штуцер латунный
Ø 30x20 mm с
углублением

**raccordo ottone
Ø 30x20 mm**



R619

Accesorio de Ø 30x20
mm de latón con
cuello

Raccord en laiton
Ø 30x20 mm avec
évidement

Brass Hose Nipple
ES.17 Male 3/8 7.5

Штуцер
гофрированный из
латуни "nana" ES.17
3/8 7,5

**portagomme
ottone es. 17
maschio 3/8 7,5**



R013T

Niple macho de latón
ES.17 3/8 7.5

Porte-tuyau en laiton
ES.17 mâle 3/8 7,5

Adapter Fitting for
Brush M10 1/8M

Адаптер-переходник
для щетки M10 1/8
"nana"

**raccordo
adattatore
spazzolino M10
1/8M**



RIP5227

Accesorio adaptador
para cepillo M10 1/8M

Adaptateur de brosse
M10 1/8M

Adapter Fitting for
Brush M10 1/8

Адаптер-
переходник для
щетки M10 1/8

**raccordo
adattatore
spazzolino M10
1/8**



RIP5228

Accesorio adaptador
para cepillo M10 1/8

Adaptateur de brosse
M10 1/8

Silicone Level Fitting
with 2 Clamps

Хомуты с
силиконовой
прокладкой для
стеклянной трубки

**raccordo livello
silicone e due
fascette**



MV6

Fitting de nivel
de silicona con 2
abrazaderas

Raccord de niveau
avec teflon/2 attaches

codici

MV5



**tubo vetro livello
acqua**
Ø 10x130 mm

Water Level Glass
Tube Ø 10x130 mm

Трубка уровня воды
стеклянная
Ø 10x130 mm

Tubo de vidrio de nivel
de agua Ø 10x130 mm

Tube en verre pour
niveau d'eau
Ø 10x130 mm

MV5P



**tubo vetro livello
acqua**
Ø 10x220 mm

Water Level Glass
Tube Ø 10x220 mm

Трубка уровня воды
стеклянная
Ø 10x220 mm

Tubo de vidrio de nivel
de agua
Ø 10x220 mm

Tube en verre pour
niveau d'eau
Ø 10x220 mm

COB1002



**raccordo livello
teflon/2 fascette
2015**

Teflon Level Fitting
with 2 Clamps 2015

Хомуты с
тефлоновой
прокладкой для
стеклянной трубки
2015

Fitting de nivel
de teflón con 2
abrazaderas 2015

Raccord de niveau en
teflon/2 attaches 2015

R014



**raccordo L MF
1/4**

fitting l mf 1/4

фитинг l mf 1/4

conexión en l hh de
1/4 de pulgada

raccord l mf 1/4

R003



**raccordo T MFF
1/4**

fitting t mff 1/4

фитинг t mff 1/4

conexión en t hhh de
1/4 de pulgada

raccord t mff 1/4

R109



**raccordo
automatico dir.
d. 1/8M**

automatic fitting str.
d. 1/8M

автоматический
монтаж str. d. 1/8M

conector automático
str. d. 1/8M

raccord automatique
str. d. 1/8M

*fitting reduction 1/4M
1/8F*

*цилиндрический
редукционный
фитинг 1/4M 1/8F*

**raccordo
riduzione
cilindrica
1/4M 1/8F**



codici

R022

*conector reductor
cilíndrico 1/4M 1/8H*

*joint reduction 1/4M
1/8F*

*fitting cylindric
extension 1/4M 1/4F*

*цилиндрический
фитинг-
удлинитель 1/4M
1/4F*

**raccordo
prolunga
cilindrica
1/4M 1/4F**



R029

*conector de extensión
cilíndrica 1/4M 1/4H*

*joint rallonge
cylindrique 1/4M 1/4F*

*brass bushing
es. 12x20 mm 1/8F*

*латунная втулка
наружная 12x20 мм
1/8F*

**boccola ottone
es. 12x20 mm
1/8F**



R639

*casquillo de latón
ext. 12x20 mm 1/8H*

*bague en laiton ext.
12x20 mm 1/8F*

*Brass Fitting 53mm
PG D.6.5mm*

*Штуцер латунный
53 мм PG д.6,5 мм*

**raccordo
ottone 53 mm PG
Ø 6,5 mm**



R563

*Accesorio de 53 mm
PG D.6.5 mm*

*Raccord en laiton
53mm PG d.6,5mm*

codici

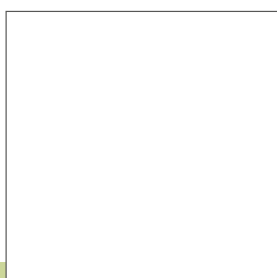
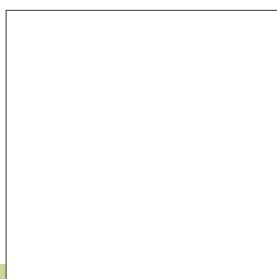
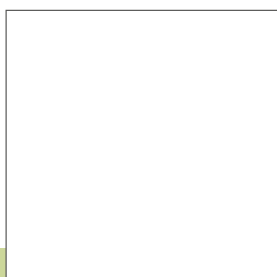
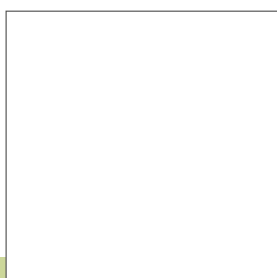
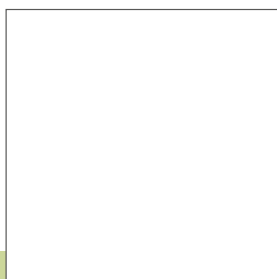
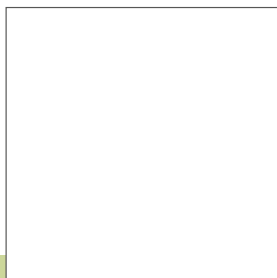

tubi e minuteria



tubes and small parts

tubos y accesorios

tubes et raccords

шланги и мелкие детали

codici

MP031M

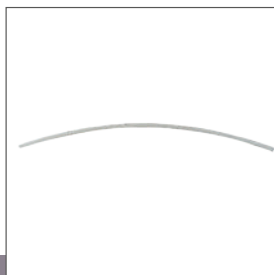

**teflon tubo 6x8
mm calibrato +/-
0,1**

*Teflon Tubing 6x8 mm
Calibrated +/-0.1*

*Трубка тефлоновая
6x8 мм калибр.
+/-0,1*

*Tubo de Teflón 6x8
mm Calibrado +/-0.1*

*Tube en téflon calibré
6x8 mm +/-0,1*

MP035M

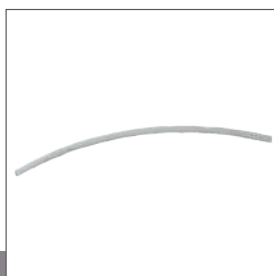

**teflon tubo 4x6
mm calibrato +/-
0,1**

*Teflon Tubing 4x6 mm
Calibrated +/-0.1*

*Трубка тефлоновая
4x6 мм калибр.
+/-0,1*

*Tubo de Teflón 4x6
mm Calibrado +/-0.1*

*Tube en téflon calibré
4x6 mm +/-0,1*

AR84



**tubo silicone
rosso 5x10 mm
calzato nero**

*Red Silicone Tube
5x10 mm Fitted Black
50 meters*

*Красная
силиконовая трубка
5x10 мм в черной*

*Tubo de Silicona Roja
5x10 mm Montado
Negro 50 metros*

*Tube en silicone rouge
5x10 mm calibré noir
(par 50 mètres)*

MP146

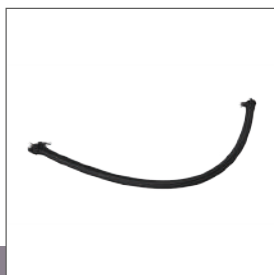

**tubo EPDM
5,8x11 mm
calzato
(al metro)**

*EPDM Tube 5.8x11
mm Fitted (Per Meter)*

*Трубка EPDM 5,8x11
мм в обмотке (x
метр)*

*Tubo de EPDM 5.8x11
mm Montado (Por
Metro)*

*Tube EPDM calibré
5,8x11 mm (au mètre)*

C27



**tubo EPDM 5x10
mm calzato nero
(al metro)**

*EPDM Steam Tube
5x10 mm Fitted Black
(Per Meter)*

*Трубка паровая EPDM
5x10 мм в черной
обмотке (x метр)*

*Tubo de Vapor de
EPDM 5x10 mm
Montado Negro (Por*

*Tube à vapeur EPDM
calibré 5x10 mm noir
(au mètre)*

C27M



**tubo EPDM 5x10
mm calzato
50 m**

*EPDM Steam Tube
5x10 mm Fitted Black
50 meters*

*Трубка паровая EPDM
5x10 мм в черной
обмотке, 50 м*

*Tubo de Vapor de
EPDM 5x10 mm
Montado Negro 50
metros*

*Tube à vapeur EPDM
calibré 5x10 mm noir
(par 50 mètres)*

EPDM Tube 4.5x8.5 mm Bare
Трубка EPDM 4,5x8,5 мм без обмотки

**tubo EPDM
4,5x8,5 mm nudo**

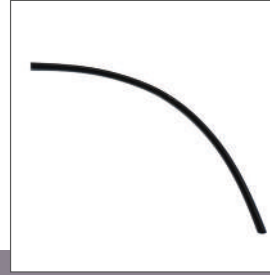

codici

MP078A

Tubo de EPDM 4.5x8.5 mm Sin Montar
Tube EPDM nu 4,5x8,5 mm

EPDM Tube 6x9 mm (Per Meter)
Трубка EPDM 6x9 мм (x метр)

**tubo EPDM
6x9 mm
(al metro)**

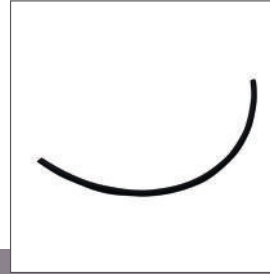

MP067

Tubo de EPDM 6x9 mm (Por Metro)
Tube EPDM 6x9 mm (au mètre)

Steel Tubes Kit for CLEAN VAPOR 2019
Набор стальных трубок CLEAN VAPOR 2019

**kit tubi acciaio
CLEAN VAPOR
2019**



KITCV02

Kit de Tubos de Acero para Vapor Limpio 2019
Kit de tuyaux en acier pour CLEAN VAPOR 2019

PTFE Tube 1/4 AISI304 Small Thickness
Трубка PTFE 1/4 AISI304 тонкая стенка

**tubo PTFE 1/4
ASI304 spessore
piccolo**

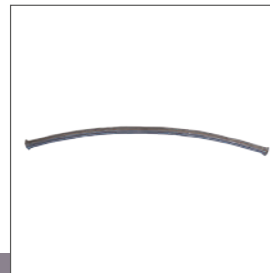

MP154

Tubo de PTFE 1/4 AISI304 de Grosor Pequeño
Tube PTFE 1/4 AISI304 épaisseur mince

PTFE Tube 1/8 AISI304 Medium Thickness
Трубка PTFE 1/8 AISI304 стенка средней толщины

**tubo PTFE 1/4
ASI304 spessore
medio**

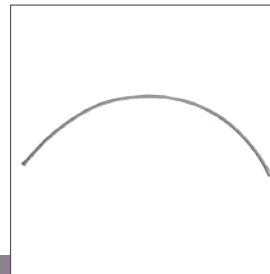

MP161

Tubo de PTFE 1/8 AISI304 de Grosor Medio
Tube PTFE 1/8 AISI304 épaisseur moyenne

Steel Tubes Kit for Carwash
Набор стальных трубок для Carwash

**kit tubi acciaio
CARWASH**



KITCW02

Kit de Tubos de Acero para Autolavado
Kit de tuyaux en acier pour Carwash

codici

KITVB01



**kit tubi acciaio
VAPOBUS 2019**

*Steel Tubes Kit for
Vapobus 2019*

*Набор стальных
трубок для Vapobus
2019*

*Kit de Tubos de Acero
para Vapobus 2019*

*Kit de tuyaux en acier
pour Vapobus 2019*

C27R



**tubo silicone
rosso 5x10 mm
calzato doppio**

*Red Silicone Double
Fitted Tube 5x10
mm*

*Красная
силиконовая трубка
5x10 мм в двойной*

*Tubo Doble Montado
de Silicona Roja 5x10
mm*

*Double tube en
silicone rouge 5x10
mmcalibré*

AR22



**faston occhiello
Ø 4 mm piccolo**

*Small Flat Faston
Terminal Ø 4 mm*

*Клемма с кольцом
Ø 4 мм, маленькая*

*Terminal Faston
Plano Pequeño Ø 4
mm*

*Cosse Faston Ø 4 mm
Petite*

AR22B



faston a bandiera

Flag Faston Terminal

Клемма с флажком

*Terminal Faston de
Bandera*

Cosse à drapeau

AR22F



**faston Ø 6,3 mm
femmina sezione
0,5/1 mm**

*Ø 6.3 mm Female
Faston Terminal
Section 0.5/1 mm*

*Клемма Ø 6,3 mm
"мама", сечение 0,5/1
mm*

*Terminal Faston
Hembra de Ø 6.3 mm
Sección 0.5/1 mm*

*Cosse femelle Ø 6,3
mm section 0,5/1 mm*

AR22M



**faston Ø 6,3 mm
maschio sezione
0,5/1 mm**

*Ø 6.3 mm Male
Faston Terminal
Section 0.5/1 mm*

*Клемма Ø 6,3 "nana",
сечение 0,5/1 mm*

*Terminal Faston
Macho de Ø 6.3 mm
Sección 0.5/1 mm*

*Cosse mâle Ø 6,3 mm
section 0,5/1 mm*

codici

C19

Standard Handle for
Bieffe Generators

Стандартная
ручка для
парогенераторов
Bieffe

**maniglia
standard
generatori
BIEFFE**



Mango Estándar para
Generadores Bieffe

Poignée standard pour
générateurs Bieffe

Cable Gland Ø 50 mm

Проходная втулка
для кабеля Ø 50 мм

passacavo Ø 50



Tuerca de Sujeción de
Cable d.50

Passe-câble Ø 50 mm

CV215

Teflon Roll
12X0.1 mm
12 m

Тefлоновая лента,
рулон
12X 0,1 мм
12 м

**rotolo teflon
12x0,1 mm
12 m**



Rollo de Teflón 12X0.1
mm
12m

Rouleau de téflon
12X0,1 mm
12m

AR83

Plastic Funnel Ø 76
mm right/left

Воронка
пластиковая, Ø 76
мм

**imbuto di
plastica
Ø 76 mm dx/sx**



Embudo de Plástico
Ø 76 mm Derecha/
Izquierda

Entonnoir en plastique
Ø 76 mm gauche/
droite

CW08B

Rubber Sleeve Ø 38
mm

Резиновый манжет
Ø 38 mm

**manicotto di
gomma
Ø 38 mm**



Manga de Goma Ø
38 mm

Manchon en
caoutchouc
Ø 38 mm

C226

Handle for BFC M6
Cabinet

Ручка дверцы M/136
BFC M6

**maniglia
sportello M/136
BFC M6**



Mango para Armario
BFC M6

Poignée de porte
M/136 BFC M6

COP0021

codici

R531B



canotto di ottone
Ø 10x130 mm

Brass Canotto
Ø 10x130 mm

Трубка латунная
Ø 10 мм x 130 мм

Canotto de Latón
Ø 10x130 mm

Tube en laiton
Ø 10x130 mm

MG10



cerniera
Ø 26 mm nikel
con gomma

Nickel Hinge Ø 26 mm
with Spring

Шарнир с никелевым
покрытием и
пружиной, Ø26 мм

Bisagra de Níquel
Ø 26 mm con Resorte

Charnière Ø 26 mm
nickel avec ressort

MV9



passacavo
Ø 9/2/12 mm

Cable Gland
Ø 9/2/12 mm

Проходная втулка
для кабеля
Ø 9/2/12 mm

Tuerca de Sujeción de
Cable Ø 9/2/12 mm

Passe-câble diamètre
Ø 9/2/12 mm

C86



passacavo
Ø 16/21 mm

Cable Gland
Ø 16/21 mm

Проходная втулка
для кабеля Ø 16/21
mm

Tuerca de Sujeción de
Cable Ø 16/21 mm

Passe-câble Ø 16/21
mm

R541



reggiasta di
ottone
Ø 12x18 mm

Brass Reggiasta
Ø 12x18 mm

Крепление антенны
из латуни Ø 12x18
mm

Reggiasta de Latón
Ø 12x18 mm

Support en laiton
Ø 12x18 mm

COM1004



passacavo
Ø 12/2/17 mm

Cable Gland
Ø 12/2/17 mm

Проходная втулка
для кабеля Ø 12/2/17
mm

Tuerca de Sujeción de
Cable Ø 12/2/17 mm

Passe-câble Ø 12/2/17
mm

Black Mushroom-shaped Base Foot
Ø 12x6x3.8 mm

Круглая ножка для основания черная,
Ø 12 мм, h 6 мм

**piedino
basamento
a fungo nero
12x6x3,8 mm**



codici

BV19

Base en Forma de Hongo Negra
Ø 12x6x3.8 mm

Base en Forma de Hongo Negra
Ø 12x6x3.8 mm

Black Bumper Foot
Ø 19 h.22 mm

Ножка черная
Ø 19 мм, h 22 мм

**piedino paracolpi
nero Ø 19 mm
h. 22 mm**



COP0120

Pata de Parachoques Negra Ø 19 h.22 mm

Embout en caoutchouc noir en forme de champignon
Ø 19 h.22 mm

White Bumper Foot
Ø 19 h.13 mm

Ножка белая
Ø 19 мм, h 13 мм

**piedino paracolpi
bianco Ø 19 mm
h. 13 mm**



COP0122

Pata de Parachoques Blanca Ø 19 h.13 mm

Embouts en caoutchouc blanc en forme de champignon
Ø 19 h.13 mm

6.3 mm Female No Flame Faston Cap

Изолятор для клеммы 6,3 мм "мама", не воспламеняющаяся

**coprifaston
femmina
6,3 mm
no flame**



AR19

Tapa Faston Sin Llama de 6.3 mm Hembra

Capuchon de borne femelle 6,3 mm sans flamme

6.3 mm Male No Flame Faston Cap

Изолятор для клеммы 6,3 мм, "папа" не воспламеняющаяся

**coprifaston
maschio
6,3 mm
no flame**



AR19M

Tapa Faston Sin Llama de 6.3 mm Macho

Capuchon de borne mâle 6,3 mm sans flamme

Silicone Glass Sleeve
Ø 8 mm

Гофра силиконовая
Ø 8 мм

**guaina vetro di
silicone
Ø 8 mm**

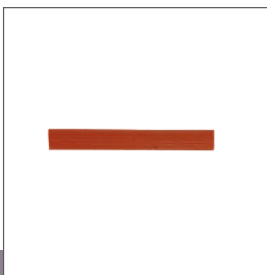

MAP1013

Manga de Vidrio de Silicona Ø 8 mm

Manchon en verre de silicone Ø 8 mm

codici

MAP1012



**guaina vetro di
silicone**
Ø 6 mm

Silicone Glass Sleeve
Ø 6 mm

Гофра силиконовая
Ø 6 mm

*Manga de Vidrio de
Silicona Ø 6 mm*

*Manchon en verre de
silicone Ø 6 mm*

MAP1011



**guaina vetro di
silicone**
Ø 4 mm

Silicone Glass Sleeve
Ø 4 mm

Гофра силиконовая
Ø 4 mm

*Manga de Vidrio de
Silicona Ø 4 mm*

*Manchon en verre de
silicone Ø 4 mm*

R531C



canotto di ottone
Ø 10x218 mm

Brass Canotto
Ø 10x218 mm

Трубка латунная
Ø 10 мм x 218 мм

Canotto de Latón
Ø 10x218 mm

Tube en laiton
Ø 10x218 mm

RIP0261

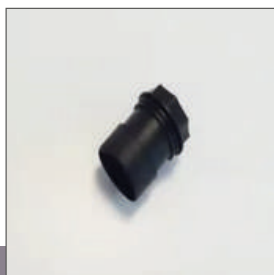

**manicotto
bocchettone per
flessibile**

*Rubber Sleeve for
Hose Nozzle*

*Соединительная
втулка для шланга*

*Manga de Goma para
Boquilla de Manguera*

*Manchon de
raccordement pour
flexible*

MAP3009



**flex tubo per
pistole vapore
K1H - PVC**
Ø 17 mm
(al metro)

*Ø 17 mm PVC Flex
Tube for K1H Steam
Guns (per meter)*

*Трубка Flex для
паровых пистолетов
K1H-PVC Ø 17 мм (x
метр)*

*Tubo de PVC Flex
para Pistolas de
Vapor K1H Ø 17
mm (por metro)*

*Tuyau Flex pour
pistolets à vapeur
K1H-PVC Ø 17 mm
(au mètre)*

TS19



**molla di acciaio
fodere tavolo**
Ø 8x120 mm

*Steel Table Cover
Spring Ø 8x120 mm*

*Стальная пружина
для обивки стола
Ø 8x120 мм*

*Resorte de Cubierta
de Mesa de Acero
Ø 8x120 mm*

*Ressort en acier pour
doublure de table
Ø 8x120 mm*

Steel Braccetto Cover
Spring
Ø 8x12 mm

Стальная пружина
для рукавной
колодки
Ø 8x12 мм

**molla di acciaio
fodere braccetto
Ø 8x120 mm**



codici

TS19A

Resorte de Cubierta
de Braccetto de Acero
Ø 8x12 mm

Ressort en acier pour
doublure de bras
Ø 8x12 mm

Zinc-Plated Conical
Spring Wire 2 mm for
Carfon

Коническая пружина,
оцинкованная 2 мм,
для карфона

**molla conica filo
2 mm zincata per
CARFON**



COF6002

Alambre de Resorte
Cónico Galvanizado 2
mm para Carfon

Ressort conique fil 2
mm galvanisé pour
Carfon

Spring Ø 18/21 mm
Wire 2 mm 125 mm
Open

Пружина
Ø 18/21 mm 2 мм
125 мм открытая

**molla
Ø 18/21 mm filo
2 mm 125 mm
aperta**



CW109

Resorte
Ø 18/21 mm Alambre
2 mm 125 mm Abierto

Ressort Ø 18/21 mm fil
2 mm 125 mm ouvert

1.4x11.8x40 mm
Spring 5mm Pitch
Stainless Steel

Пружина
1,4x11,8x40 mm
нержавеющая
сталь 5

**molla
1,4x11,8x40 mm
passo 5 inox**



TA7B

Resorte
1.4x11.8x40 mm Paso
de 5 mm de Acero
Inoxidable

Ressort
1,4x11,8x40 mm pas
de 5 inox

PVC hose Ø 80 mm

Труба ПВХ Ø 80 мм

**tubo PVC grigio Ø
80 mm**



COP2004

Tubo PVC Ø 80 mm

Tuyau PVC Ø 80 mm

cable slim Ø 19,5/24

Кабельный герметик
Ø 19,5/24

**passacavo Ø
19,5/24 mm**



COM1002

Pasacables Ø 19,5/24

Presse-étoupe Ø
19,5/24

codici

MAP0025



**tubo EPDM
Ø 11x15,5 mm
nudo**

*hose epdm Ø 11x15,5
not covered*

*труба epdm Ø
11x15,5*

*tubo epdm Ø 11x15,5
liso*

*tubo epdm Ø 11x15,5
liso*

MAP0026



**tubo EPDM
Ø 9x12,5 mm
nudo**

*steam hose epdm Ø
9x12,5 not covered*

труба epdm Ø 9x12,5

*tubo epdm Ø 9x12,5
liso*

*tuyau epdm Ø 9x12.5
nu*

MP090



**tubo EPDM
Ø 4,5x8,5 mm
calzato nero**

*epdm hose Ø 4,5x8,5
covered black*

*Труба EPDM
Ø 4,5x8,5 черная, в
оплетке*

*tubo epdm Ø 4,5x8,5
negro ajustado*

*tuyau epdm Ø 4,5x8,5
noir ajusté*

MP070B



**teflon tubo
Ø 2x4 mm**

teflon hose Ø 2x4mm

*тефлоновая трубка
Ø 2x4 mm*

*tubo de teflón Ø 2x4
mm*

*tuyau en téflon Ø 2x4
mm*

MAP0023



**tubo EPDM
Ø 5x10 mm
doppia calza**

*hose epdm Ø 5x10
mm double covered*

*труба epdm Ø
5x10 mm двойная
оболочка*

*tubo epdm Ø 5x10
mm doble funda*

*tuyau epdm Ø 5x10
mm double manchon*

COP1012



**puntale
25x25 cm nero**

*Black end cap 25x25
cm*

*Черный наконечник
25x25 cm*

*Tapón final negro
25x25 cm*

*Embouts noirs 25x25
cm*

head cover
30x30 mm black

головной убор
30x30 мм черный

**copritesta
30x30 mm nero**



codici

COP1014

cubierta de la cabeza
30x30 mm negro

couvre-chef
30x30 mm noir

fiberglass U-bolt for
vacuum table

U-образный болт из
стекловолокна для
вакуумного стола

**cavallotto fibra di
vetro per tavolo
aspirante**



COP0103

Perno en U de fibra de
vidrio para mesa de
vacío.

Boulon en U en fibre
de verre pour table à
vide

black head cover
Ø 25 mm

черный головной
убор
Ø 25 мм

**coperitesta nero
Ø 25 mm**



COP0121

cubierta de cabeza
negra Ø25mm

couvre-chef noir
Ø 25 mm

codici

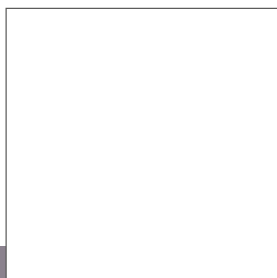
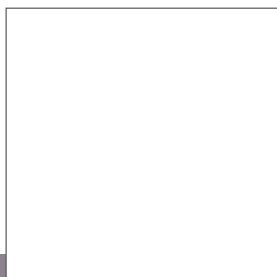
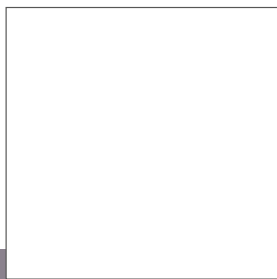
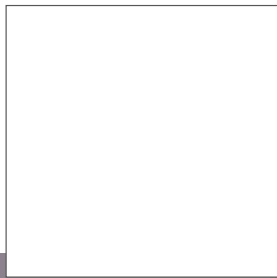

prese e
spine vapore



BIEFFE[®]
FARINELLI
GENERATORI DI VAPORE

steam sockets and plugs
tomas y enchufes de vapor
prises et fiches vapeur
разъемы и штуцеры

codici

AR129



spina ILME 5 poli

ILME 5-Pole Plug

*Вилка ILME
5-контактная*

*ILME Enchufe de 5
Polos*

Fiche ILME 5 broches

AR130



**spina ILME
femmina 5 poli**

ILME 5-Pole Socket

*Разъем ILME "мама"
5-контактный*

ILME Toma de 5 Polos

*Prise ILME femelle 5
broches*

AR183



**frutto spina ILME
5 poli
10A**

*ILME 5-Pole Plug
Socket 10A*

*Разъем электр.
для вилки ILME
5-контактн. 10A*

*ILME Enchufe Toma
de 5 Polos 10A*

*Fiche ILME 5 broches
10A*

AR181



**frutto presa ILME
5 poli
10A**

*ILME 5-Pole Socket
Socket 10A*

*Разъем электр.
для розетки ILME
5-контактн. 10A*

*ILME Toma Toma de 5
Polos 10A*

*Prise ILME 5 broches
10A*

C65



**spina ILME 4 poli
completa**

*ILME 4-Pole Complete
Plug*

*Вилка ILME
4-контактная в
сборе*

*ILME Enchufe
Completo de 4 Polos
Metro)*

*Fiche ILME 4 broches
complète*

C66



**presa ILME 4 poli
completa**

*ILME 4-Pole Complete
Socket*

*Разъем ILME
4-контактный в
сборе*

*ILME Toma Completa
de 4 Polos*

*Prise ILME 4 broches
complète*

ILME 4-Pole Plug
Socket 10A

Разъем электр.
для розетки ILME
4-контактной 10A

frutto presa ILME
4 poli
10A



codici

AR180

ILME Enchufe Toma
de 4 Polos 10A

Prise ILME 4 broches
10A

ILME 4-Pole Socket
Socket 10A

Разъем электр.
для вилки ILME
4-контактной 10A

frutto spina ILME
4 poli
10A



AR182

ILME Toma Toma de 4
Polos 10A

Fiche ILME 4 broches
10A

Forever Complete
ILME Socket

Разъем ILME в сборе
FOREVER

presa ILME
completa
FOREVER

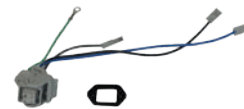

AV101

Toma ILME Completa
para Forever

Prise ILME complète
Forever

MAXI VAPOR
Complete ILME
Socket

Разъем ILME в сборе
MAXI VAPOR

presa ILME
completa MAXI
VAPOR



MV106

Toma ILME Completa
para MAXI VAPOR

Prise ILME complète
MAXI VAPOR

MAXI VAPOR Plus
Complete ILME
Socket

Разъем ILME в сборе
MAXI VAPOR PLUS

presa ILME
completa MAXI
VAPOR PLUS



MV106P

Toma ILME Completa
para MAXI VAPOR
Plus

Prise ILME complète
MAXI VAPOR Plus

90° Automatic
Complete ILME
4-Pole Socket

Разъем ILME
4-контактный 90°
Automatic в сборе

presa ILME 4 poli
completa 90°
AUTOMATIC



AV101B

Toma ILME Completa
de 90° Automático
para 4 Polos

Prise ILME 4 broches
complète 90°
Automatic

codici

COP0203



**presa vapore
blocco plastica**

*Steam Block Plastic
Socket*

*Разъем паровой
пластиковый корпус*

*Toma de Plástico para
Bloqueo de Vapor*

*Prise vapeur Bloc en
plastique*

CW48

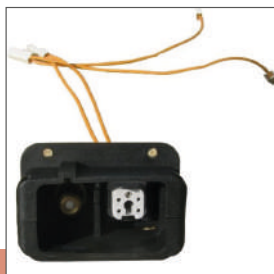

**presa vapore /
acqua CARWASH
completa**

*Carwash Complete
Steam/Water Socket*

*Разъем пар/вода
CARWASH в сборе*

*Toma Completa de
Autolavado para
Vapor/Agua*

*Prise vapeur/eau
Carwash complète*

CV107

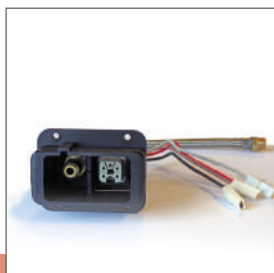

**presa vapore
CLEAN VAPOR
completa**

*CLEAN VAPOR
Complete Steam
Socket*

*Разъем паровой
CLEAN VAPOR в
сборе*

*Toma Completa de
Vapor Limpio*

*Prise vapeur CLEAN
VAPOR complète*

MG108

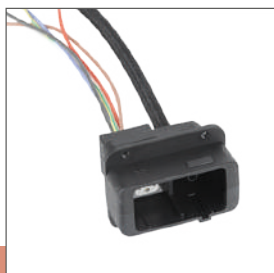

**presa vapore
MAGIC VAPOR RA
completa**

*Magic Vapor RA
Complete Steam
Socket*

*Разъем паровой
MAGIC VAPOR RA в
сборе*

*Toma Completa de
Magic Vapor RA para
Vapor*

*Prise vapeur Magic
Vapor RA complète*

CW48



**presa vapore /
acqua VAPOBUS
completa**

*Vapobus Complete
Steam/Water Socket*

*Разъем пар/вода
VAPOBUS в сборе*

*Toma Completa de
Vapobus para Vapor/
Agua*

*Prise vapeur/eau
Vapobus complète*

CV127

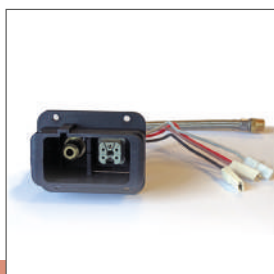

**presa vapore
CLEAN VAPOR
JUNIOR
completa**

*CLEAN VAPOR Junior
Complete Steam
Socket*

*Разъем паровой
CLEAN VAPOR
JUNIOR в сборе*

*Toma Completa de
Vapor Limpio Junior
para Vapor*

*Prise vapeur CLEAN
VAPOR Junior
complète*

Magic Vapor
Complete Steam
Socket

Разъем паровой
MAGIC VAPOR в
сборе

**presa vapore
MAGIC VAPOR
completa**



codici

MG123

Toma Completa de
Magic Vapor para
Vapor

Prise vapeur Magic
Vapor complète

Magic Vapor/Emilio
Complete Steam Plug

Разъем паровой
MAGIC VAPOR/
EMILIO в сборе

**spina vapore
MAGIC VAPOR /
EMILIO completa**



MGS/C

Toma/Enchufe
Completa de Magic
Vapor/Emilio para

Fiche vapeur Magic
Vapor/Emilio complète

CLEAN VAPOR/Junior
Complete Steam
Plug

Разъем паровой
CLEAN VAPOR/
JUNIOR в сборе

**spina vapore
CLEAN VAPOR /
JUNIOR completa**



CV106

toma/Enchufe
Completa de Vapor
Limpio/Junior para
Vapor

Fiche vapeur CLEAN
VAPOR/Junior
complète

Carwash/Vapobus
Complete Mechanical
Steam Plug

Разъем паровой
механический
CARWASH/VAPOBUS
в сборе

**spina vapore
meccanica
CARWASH
/ VAPOBUS
completa**



CW47

Toma/Enchufe
Mecánica Completa
de Autolavado/
Vapobus para Vapor

Fiche vapeur
mécanique Carwash/
Vapobus complète

White Silicone
Funghetto 85 mm

Белая силиконовая
втулка 85 mm

**funghetto
silicone bianco
85 mm**

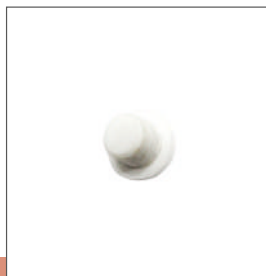

COP2005

Funghetto de Silicona
Blanca 85 mm

Petit embout en
silicone blanc 85 mm

Steam Block Plastic
Socket

Разъем паровой
пластиковый корпус

**spina vapore
blocco plastica**



COP0204

Toma de Plástico para
Bloqueo de Vapor

Fiche vapeur Bloc en
plastique

codici

COM1012



**sfera Ø 5 mm /
16 gr
1000 AISI 420**

Ø 5 mm/16 gr. 1000
AISI 420 Steel Ball

Шарик Ø 5mm/16 гр.
1000 AISI 420

Bola de Acero AISI
420 Ø 5 mm/16gr.

Bille Ø 5mm/16gr.
1000 AISI 420

COF6003



**molla presa
vapore
meccanica
Ø 8 mm
h 48 mm**

Steam Mechanical
Socket Spring Ø 8 mm
h48 mm

Пружина для
механического
парового разъема Ø

Resorte de Toma
Mecánica de Vapor Ø
8 mm h48 mm

Ressort prise vapeur
mécanique Ø 8 h48
mm

R621



**ugello maschio
ottone presa
vapore Ø 18 mm
1/8 F**

Brass Male Nozzle for
Steam Socket Ø 18
mm 1/8F

Латунный штуцер
"папа" Ø 18 mm 1/8F
разъема обмотки,

Boquilla Macho de
Latón para Toma
de Vapor Ø 18 mm

Embouchure mâle
en laiton pour prise
vapeur Ø 18 mm

MGP03



**ugello femmina
spina vapore PG6**

Female Nozzle for
Steam Plug PG. 6

Штуцер "мама" для
парового разъема
PG. 6

Boquilla Hembra para
Enchufe de Vapor PG.
6

Embouchure femelle
pour fiche vapeur
PG. 6

MGP01



**ugello maschio
presa vapore PG6**

Male Nozzle for
Steam Socket PG. 6

Штуцер "папа" для
парового разъема
PG. 6

Embouchure mâle
pour prise vapeur
PG. 6

Tube à vapeur EPDM
calibré 5x10 mm noir
(au mètre)

CW48A



**ugello maschio
ottone presa
meccanica**

Brass Male Nozzle for
Mechanical Socket

Латунный
штуцер "папа"
для механического
разъема
Embouchure mâle
en laiton pour prise
mécanique

Boquilla Macho de
Latón para Toma
Mecánica

Female Nozzle for
Mechanical Plug

Штуцер "мама"
для механического
парового разъема

**ugello femmina
spina meccanica**



codici

CW47A

Boquilla Hembra para
Enchufe Mecánico

Embouchure femelle
pour fiche mécanique

Brass Female Socket
OT Nozzle Ø 22x65
mm

Щтуцер "мама"
OT. для парового
разъема Ø 22x65 mm

**ugello femmina
OT spina vapore
Ø 22x65 mm**



R571

Boquilla Hembra de
Latón para Toma OT
Ø 22x65 mm

Embouchure femelle
pour fiche vapeur Ø
22x65 mm

Steam Socket O-Ring
9.25x1.78 mm

Уплотнительное
кольцо OR для
парового разъема
9,25x1,78 mm

**OR presa vapore
9,25x1,78 mm**



MGOR

Anillo O-Ring para
Toma de Vapor
9.25x1.78 mm

Joints toriques pour
prise vapeur 9,25x1,78
mm

steam socket magic
vapor 5 poles

розетка для пара
magic vapor 5
контактов

**presa vapore
MAGIC VAPOR
5 poli**

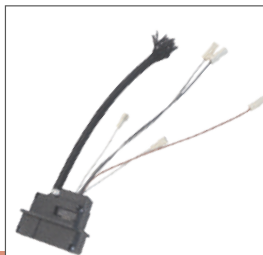

MG122

toma de vapor magic
vapor 5 polos

prise vapeur magic
vapor 5 pôles

codici



**motori, pedaliere
aspiratori,
fusti e filtri**



**Motors, pedal assemblies, vacuums,
drums, filters**

**Motores, pedales, aspiradores,
tambores, filtros**

**Moteurs, pedales, aspirateurs,
futs, filtres**

**двигатели, педали, aspirаторы, баки,
фильтры**

codici

COE2604



gruppo motore aspirante cavo lungo per tavolo rett. RIP 2010+ Scarpavapor No Limits

Long Cable Aspirator Motor Group for Rectangular Table

Мотор для аспирации в сборе с длинным кабелем для прямоугольного стола/RIP2010/BF426S

Grupo Motor Aspirante Cable Largo Para Mesa Rectangular

Groupe Moteur Aspirant Câble Long Pour Table Rectangulaire

TS15

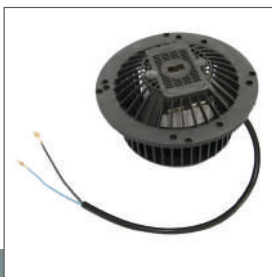

gruppo motore aspirante cavo lungo per tavolo

Aspirator Motor Group for Table

Мотор для аспирации в сборе для гладкого стола

Grupo Motor Aspirante Para Mesa

Groupe Moteur Aspirant Pour Table

TS15F



gruppo motore aspirante per tavolo con aggancio per filtro

Aspirator Motor Group for Table with Filter Attachment

Мотор для аспирации в сборе для гладкого стола с креплением

Grupo Motor Aspirante Para Mesa Con Enganche Para Filtro

Groupe Moteur Aspirant Pour Table Avec Attache Pour Filtre

TS6



convogliatore a chiocciola aspirante

Spiral Aspirating Conveyor

Корпус пластиковый для вакуумного мотора

Conducto de Espiral Aspirante

Convoyeur à Spirale Aspirant

TS15A



ventola girante per motore

Fan Blade for Motor

Крыльчатка вакуумного мотора

Hélice de Ventilador para Motor

Ventilateur Rotatif Pour Moteur

TS15B



coperchio per motore

Motor Cover

Крышка для вакуумного мотора

Tapa de Motor

Couvercle Pour Moteur

CARWASH 2018 WL
1200W Motor with
Conveyor

Мотор CARWASH
2018 WL 1200 Вт

**motore CARWASH
2018 WL
1200 W con
convogliatore**

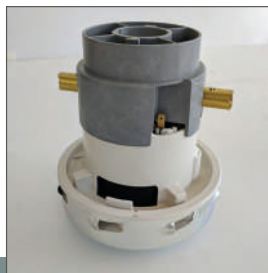

codici

COE2523

Motor CARWASH
2018 WL 1200W Con
Conducto

Moteur CARWASH
2018 WL 1200W Avec
Convoyeur

Carwash 2018 Motor
Kit + Box

Комплект мотор
Carwash 2018 + коробка

**kit motore
CARWASH con
scatola**

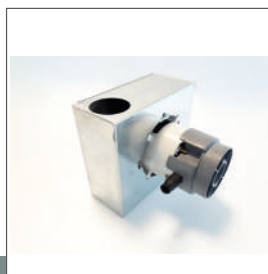

KIT5108

Kit de Motor Carwash
2018 + Caja

Kit Moteur Carwash
2018 + Boîte

Carwash 2018 Motor
Kit + Box + Partition for
Previous Carwash

Комплект мотор
Carwash 2018 +
коробка + перегородка
для предыдущих
версий Carwash
Kit Moteur Carwash
2018 + Boîte +
Cloison Pour Carwash
Précédents

**kit motore
CARWASH con
scatola e paratia
per CARWASH
precedenti**

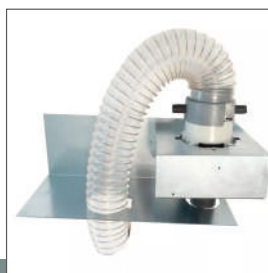

KIT5106

Kit de Motor Carwash
2018 + Caja + Separador
para Carwash
Anteriores

GX1000 300W Fan
Motor

Мотор
вентилятора
GX1000 300 Вт

**motore
ventilatore
GX1000 300 W**



COE2521

Motor Ventilador
GX1000 300W

Moteur Ventilateur
GX1000 300W

Sheet Metal Blade for
GX1000 300W Motor

Крыльчатка для
мотора GX1000 300
Вт

**girante in
lamiera motore
GX1000 300 W**

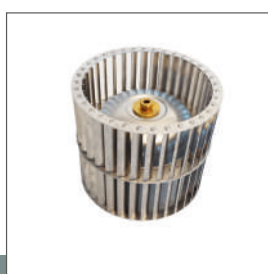

COE2522

Hélice de Chapa para
Motor GX1000 300W

Hélice En Tôle Pour
Moteur GX1000 300W

Two-stage Aspirator
1,400W Yellow Head

Мотор для
аспирации
двухступенчатый
1.400 Вт с желтой
головкой

**aspiratore
bistadio 1400 W
testa gialla**



RIP1111

Aspirador Bifásico
1.400W con Cabeza
Amarilla

Aspirateur Bistade
1.400W Tête Jaune

codici

RIP1110



**aspiratore
bistadio 1400 W
testa nera**

*Two-stage Aspirator
1,400W Black Head*

*Мотор для аспирации
двухступенчатый
1.400 Вт с черной
головкой*

*Aspirador Bifásico
1.400W con Cabeza
Negra*

*Aspirateur Bistade
1.400W Tête Noire*

RIP1152_01



**aspiratore
bistadio 1000 W
testa nera**

*Two-stage Aspirator
1,000W Black Head*

*Мотор для аспирации
двухступенчатый
1.000 Вт с черной
головкой*

*Aspirador Bifásico
1.000W con Cabeza
Negra*

*Aspirateur Bistade
1.000W Tête Noire*

COE5001



**motore chiuso
187 W ventilato
esterno 230 V 50
Hz**

*Closed Motor 187
WATT Ventilated
External 230V 50Hz*

*Закрытый мотор
187 Вт, внешнее
охлаждение, 230 В,
50 Гц*

*Motor Cerrado 187
WATT Ventilado
Externo 230V 50Hz*

*Moteur Fermé
187 WATT Ventilé
Extérieurement 230V*

COE5011



**motore chiuso
187 W / 115 V
ventilato 60 Hz**

*Closed Motor
187 WATT/115V
Ventilated 60Hz*

*Закрытый мотор
187 Вт/115 В, с
охлаждением, 60 Гц*

*Motor Cerrado 187
WATT/115V Ventilado
60Hz*

*Moteur Fermé 187
WATT/115V Ventilé
60Hz*

COE5004



**motore chiuso
245 W ventilato
esterno 230 V
50/60 Hz**

*Closed Motor 245
WATT Ventilated
External 230V*

*Закрытый мотор
245 Вт, внешнее
охлаждение, 230 В,
50/60 Гц*

*Motor Cerrado 245
WATT Ventilado
Externo 230V*

*Moteur Fermé
245 WATT Ventilé
Extérieurement 230V*

Carbon Filter for
 Vacuum Motor

Угольный фильтр
 для вакуумного
 мотора

**filtro carboni
 per motore
 aspirazione**



codici

RIP3001

Filtro de Carbón para
 Motor de Aspiración

Filtre à Charbon Pour
 Aspiration de Moteur

Polyester EPA
 Aspirator Filter
 175x145x125

Вытяжной фильтр
 из полиэстера EPA
 175x145x125
 "nana"

**filtro aspiratore
 poliestere EPA
 175x145x125
 mm**



RIP1211

Filtro de Poliéster
 EPA para Aspirador
 175x145x125

Filtre en Polyester
 Pour Aspirateur EPA
 175x145x125

300 mm Portafilter
 Ring

Кольцо-держатель
 фильтра
 300 mm

**anello portafiltro
 300 mm**



RIP1213

Anillo Portafiltro
 300 mm

Bague Porte-Filtre
 300 mm

Polyester Aspirator
 Filter 300 mm

Фильтр из
 полиэстера для
 аспиратора
 300 мм

**filtro aspiratore
 poliestere
 300 mm**



EMF2

Filtro de Poliéster
 para Aspirador
 300 mm

Filtre en Polyester
 Pour Aspirateur
 300 mm

Complete Pedalboard
 for 1700 mm Table

Педаль для стола,
 1700 мм

**pedaliera per
 tavolo completa
 1700 mm**



COB3001

Pedal Completo para
 Mesa de 1700 mm

Pédales Pour Table
 Complète 1700 mm

Aspirating/Blowing
 Pedalboard for
 1700 mm Table

Педаль для
 стола двойная,
 (аспирация/поддув),
 1700 мм

**pedaliera per
 tavolo asp/soff
 1700 mm**



COB3002

Pedal para Mesa
 Aspirante/Soplante
 de 1700 mm

Pédales Pour Table
 Aspiration/Soufflage
 1700 mm

codici

CV105



disco bloccafiltro

Filter Locking Disc

*Диск для блокировки
фильтра*

Disco Bloqueafiltro

*Disque Bloquant du
Filtre*

RIP1104



**fusto inox per
aspiratore h 240
mm**

*Stainless Steel Drum
for Aspirator
h 240 mm*

*Бак из нерж. стали
h 240 мм для
аспиратора*

*Tambor Inoxidable
para Aspirador
h 240 mm*

*Réservoir en Acier
Inoxydable Pour
Aspirateur h 240 mm*

RIP1101

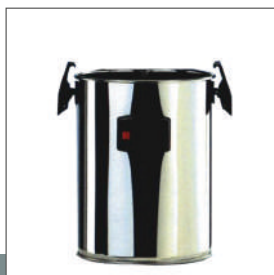

**fusto inox per
aspiratore
h 385 mm**

*Stainless Steel Drum
for Aspirator h 385
mm*

*Бак из нерж.
стали h 385 мм для
аспиратора*

*Tambor Inoxidable
para Aspirador
h 385 mm*

*Réservoir en Acier
Inoxydable Pour
Aspirateur h 385 mm*

COF3102



**fascia reggifusto
inox**

*Stainless Steel Drum
Retaining Strap*

*Обруч-держатель
для стального бака*

*Banda de Sujeción de
Tambor Inoxidable*

*Bande de Fixation en
Acier Inoxydable Pour
Réservoir*

RIP1103



**gancio fusto nero
testata**

*Black Head Metal
Drum Hook*

*Крюк-держатель
черный для бака и
мотора аспиратора*

*Gancho de Tambor
con Cabeza Negra*

*Crochet du Réservoir
Noir Tête*

RIP1221



**coperchio
separatore
300 mm
completo**

*Complete 300 mm
Separator Lid*

*Крышка сепаратора
300 мм*

*Tapa Separadora
300 mm Completa*

*Couvercle du
Séparateur 300 mm
Completo*

RED 2-Hole Dust
Suction Nozzle

Всасывающий
патрубок с красной
кнопкой и двумя
отверстиями

Boquillón de
Aspiración Pul. Rojo
de 2 Orificios

Buse d'Aspiration
Rouge 2 Trous

**bocchettone
aspirazione
pulsante rosso
due fori**



codici

RIP1222

Red Suction Nozzle
with Deflector

Всасывающий
патрубок с
обтекателем и
красной кнопкой

Boquillón de
Aspiración con
Deflector Pul. Rojo

Buse d'Aspiration
Avec Déflecteur Rouge

**bocchettone
aspirazione
con deflettore
pulsante rosso**



C173S

Suction Nozzle with
Deflector

Всасывающий
патрубок с
обтекателем

Boquillón de
Aspiración con
Deflector

Buse d'Aspiration
Avec Déflecteur

**bocchettone
aspirazione
con deflettore**



RIP1102

universal vertical
metal drum hook

Универсальный
металлический
фиксатор для бака,
вертикальный

Gancho de Tambor
Metálico Universal
Vertical

Crochet Universel en
Métal pour Réservoir
Vertical

**gancio fusto
metallico
universale
verticale**



RIP1108

universal horizontal
metal drum hook

Универсальный
металлический
фиксатор для бака,
горизонтальный

Gancho de Tambor
Metálico Universal
Horizontal

Crochet Universel en
Métal pour Réservoir
Horizontal

**gancio fusto
metallico
universale
orizzontale**



RIP1109

Aspirator/Blower
Motor

Мотор аспирация/
поддув

Motor Aspirador/
Soplador

Moteur Aspirateur/
Souffleur

**motore
aspiratore /
soffiante**



CV118

codici

EMF



**filtro aspiratore
antipolvere**

*Anti-Dust Aspirator
Filter*

*Антипылевой
фильтр*

*Filtro Anti-polvo para
Aspirador*

*Filtre Anti-Poussière
pour Aspirateur*

CVK15



**cattura polvere
in acqua**

*Dust Collection in
Water*

*Пылеуловитель для
воды*

*Captura de Polvo en
Agua*

*Collecteur de
Poussière en Eau*

COE4002



**ventola 220 VAC
120x120x38 mm**

*220VAC
120x120x38 mm Fan*

*Вентилятор
220VAC 120x120x38
мм*

*Ventilador 220VAC
120x120x38 mm*

*VENTILATEUR
220VAC
120x120x38 mm*

COE4012



**ventola
120x120x38 mm
110-120 V**

*SUNTRONIX
120x120x38 mm
110-120Volt Fan*

*Вентилятор Suntronix
120x120x38 мм
110-120 Вольт*

*Ventilador
SUNTRONIX
120x120x38 mm
110-120V*

*VENTILATEUR
SUNTRONIX
120x120x38 mm
110-120Volt*

RIP2011



**aspiratore e
aspiraliquidi
1000 W per
banco da lavoro
SCARPAVAPOR
RIP 2010**

*1000W Aspirator
and Liquid Aspirator
- For Workbench
SCARPAVAPOR*

*Мощный пылесос 1000
Вт - для стола RIP2010
SCARPAVAPOR*

*Aspirador y Soplador
1000W - Para banco de
trabajo SCARPAVAPOR
RIP2010*

*Aspirateur et Aspirateur
Liquides 1000W -
Pour Table de Travail
SCARPAVAPOR*

RIP2010



**banco da lavoro
aspirante con
luce**

*Aspirating Workbench
with Light*

*Рабочий стол
с вытяжкой и
подсветкой*

*Banco de Trabajo
Aspirante con Luz*

*Table de Travail
Aspirante avec
Lumière*

ruote



BIEFFE[®]
FARINELLI
GENERATORI DI VAPORE

wheels

ruedas

roues

колеса

codici

C180



**ruota
Ø 100 mm h 124
mm piroettante**

*Swiveling Wheel Ø
100 mm h 124 mm*

*Колесо Ø 100 mm h
124 mm поворотное*

*Rueda Ø 100 mm h
124 mm giratoria*

*Roue Ø 100 mm h 124
mm pivotante*

C180B



**ruota Ø 100 mm
h 124 mm fissa**

*Fixed Wheel Ø 100
mm h 124 mm*

*Колесо Ø 100
mm h 124 mm
фиксированное*

*Rueda Ø 100 mm h
124 mm fija*

*Roue Ø 100 mm h 124
mm fixe*

C181



**ruota Ø 100 mm
h 124 mm
girevole con
freno**

*Swiveling Wheel Ø
100 mm h 124 mm
with Brake*

*Колесо Ø 100 h 124
mm поворотное с
тормозом*

*Rueda Ø 100 mm
h 124 mm giratoria
con freno*

*Roue Ø 100 h.124 mm
Pivotante avec Frein*

COD0321



**ruota Ø 80 mm
h 25 mm fissa**

*Fixed Wheel Ø 80 mm
h 25 mm*

*Колесо Ø 80 mm h 25
mm фиксированное*

*Rueda Ø 80 mm h 25
mm fija*

*Roue Ø 80 mm h 25
mm fixe*

COD0322



**ruota Ø 80 mm
h 25 mm girevole**

*Swiveling Wheel Ø 80
mm h 25 mm*

*Колесо Ø 80 mm h 25
mm поворотное*

*Rueda Ø 80 mm h 25
mm giratoria*

*Roue Ø 80 mm h 25
mm pivotante*

COD0323



**ruota Ø 80 m
h 25 mm girevole
con freno**

*Swiveling Wheel Ø
80 mm h 25 mm with
Brake*

*Колесо Ø 80 mm h 25
mm поворотное с
тормозом*

*Rueda Ø 80 mm h 25
mm giratoria con
freno*

*Roue Ø 80 mm h.25
mm Pivotante avec
Frein*

Rubber Wheel 210x70
mm with Studs and
Round Plate

Колесо резиновое
210x70 mm

Rueda de goma
210x70 mm con
chapa GR+Ronde

Roue 210x70 mm
en Caoutchouc avec
Bague Gr+Ronde

**ruota 220x70
mm in gomma
con borchia
GR+ronde**



codici

COD0351

Double Wheel Ø 35
mm with 38x38 mm
Plate

Колесо Ø 35
mm двойное с
пластиной 38x38
mm для крепления

Rueda Ø 35 mm doble
con placa 38x38 mm

Roue Ø 35 mm Double
avec Plaque 38x38
mm

**ruota Ø 35 mm
doppia con
piastra
38x38 mm**



EM8

Double Wheel Ø 35
mm with 8x15 mm
Pin

Колесо Ø 35 mm
двойное со штырём
8x15 мм

Rueda Ø 35 mm doble
con perno 8x15mm

Roue Ø 35 mm Double
Axe 8x15mm

**ruota Ø 35 mm
doppia con perno
8x15 mm**



MG12

Antipuncture Wheel Ø
260x75 mm C/R F.20

Колесо Ø 260x75
mm C/R F.20
Противопркольное
"pana"

Rueda Ø 260x75 mm
con rodamiento F.20
antipinchazos

Roue Ø 260x75
mm avec Frein
Anticrevaison F.20

**ruota
Ø 260x75 mm
C/R F.20
antiforatura**



COD0353

Double Wheel Ø 40
mm with M8X15
NY.NE Pin

Колесо Ø 40 mm
двойное со штырём
M8X15 NY

Rueda Ø 40 mm doble
con perno M8X15
nylon

Roue Ø 40 mm Double
Axe M8X15 NY.NE

**ruota Ø 40 mm
doppia con
perno
M8x15 mm
NY.NE**



COD0301

Double Wheel Ø 40
mm with 8x20 Rid. Ø
14 mm Pin

Колесо Ø 40 mm
двойное со штырём
8x20 Ø 14 mm

Rueda Ø 40 mm
doble con perno 8x20
reducción Ø 14 mm

Roue Ø 40 mm Double
Axe 8x20 Réduite Ø
14 mm

**ruota Ø 40 mm
doppia con
perno
8x20 mm
rid. Ø 14 mm**



COD0304

codici

COD0305



**ruota Ø 40 mm
doppia con
perno
8x20 mm
rid. Ø 16 mm**

Double Wheel Ø 40 mm with 8x20 mm Rid. Ø 16 mm Pin

Колесо Ø 40 mm двойное со штырём 8x20 mm Ø 16 mm

Rueda Ø 40 mm doble con perno 8x20 mm reducción Ø 16 mm

Roue Ø 40 mm Double Axe 8x20 mm Réduite Ø 16 mm

COD0306



**ruota Ø 40 mm
doppia con
perno M8x15
mm con freno NE**

Double Wheel Ø 40 mm with M8X15 mm C/Freno NE Pin

Колесо Ø 40 mm двойное со штырём M8X15 mm и тормозом

Rueda Ø 40 mm doble con perno M8X15 mm con freno nylon

Roue Ø 40 mm Double Axe M8X15 mm avec Frein NE

RIP1234



**ruota YES
completa +
copriruota
gr 6000**

Complete Yes Wheel + Cover GR.6000

Колесо Yes в сборе с подкрылком GR.6000

Rueda Yes completa + cubierta GR.6000

Roue Yes Complète + Couvercle GR.6000

COD0352



**ruota Ø 50 mm
termogomma
con perno 8x15
mm**

Thermo Rubber Wheel Ø 50 mm with M8X15 mm Pin

Колесо Ø 50 mm терморезина со штырём 8x15 mm

Rueda Ø 50 mm termogoma perno 8X15 mm

roue Ø 50 mm en caoutchouc thermique axe 8x15 mm

RIP1161



**carrello
aspiratore YES
grigio 6000**

trolley f/vacuum yes grey 6000

тележка для пылесоса yes серого цвета 6000

carro aspirador yes gris 6000

charriot p/aspirateur yes gris 6000

detergenti e
nebulizzatori



detergents and nebulizers

detergentes y nebulizadores

detergents et nebuliseurs

моющие средства
и распылители

codici

RIP1433



**detergente
per rimozione
chewing gum
1 kg**

*Chewing Gum
Remover Detergent
- 1kg*

*Средство
для удаления
жевательной
резины - 1 кг*

*Detergente para
eliminación de chicles
- 1 kg*

*Détergent pour
Enlever le Chewing-
Gum - 1kg*

RIP1434



**detergente per
tappeserie
speciale interni
5 kg**

*Upholstery Cleaner
"Special Interiors" -
5kg*

*Чистящее средство
для текстиля, обивки
и ковров "SPECIALE
INTERNI" - 5 кг*

*Detergente para
tapicerías "SPECIALE
INTERNI" - 5 kg*

*Détergent pour
Tapisseries "SPECIALE
INTERNI" - 5kg*

RIP1452



**detergente
specifico per
pavimenti ALL
SUPER 5 kg**

*All Super Floor
Specific Detergent
- 5kg*

*Моющее средство
для полов "ALL
SUPER" - 5 кг*

*Detergente específico
para suelos "ALL
SUPER" - 5 kg*

*Détergent Spécifique
pour Sols "ALL
SUPER" - 5 KG*

RIP1453



**detergente
per motori
PLURIMOTORI
PLUS 5 kg**

*Engine Cleaner
"Pulimotori Plus" -
5kg*

*Моющее средство
для двигателей
"PULIMOTORI PLUS" - 5 кг*

*Detergente para
motores "PULIMOTORI
PLUS" - 5 kg*

*Détergent pour Moteurs
"PULIMOTORI PLUS"
- 5kg*

RIP1482



**detergente
SCARPAVAPOR
puro 5 kg**

*Pure SCARPAVAPOR
Detergent - 5kg*

*Моющее средство
SCARPAVAPOR
(концентрат) - 5 кг*

*Detergente
SCARPAVAPOR puro
- 5 kg*

*Détergent
SCARPAVAPOR Pur
- 5 kg*

RIP1483



**detergente
pretrattante
SCARPAVAPOR 5
kg**

*Pre-treatment
Detergent
SCARPAVAPOR - 5kg*

*Средство для
предварительной
обработки
SCARPAVAPOR - 5 кг*

*Detergente
pretratante
SCARPAVAPOR - 5 kg*

*Détergent
Prétraitement
SCARPAVAPOR - 5 kg*

Foam Detergent - 5kg

Пенообразующее
моющее средство
- 5 кг

**detergente
schiuma 5 kg**



codici

RIP1484

Detergente espumoso
- 5 kg

Détergent Mousseux
- 5 kg

Protective Finish
Detergent - 5kg

Защитное
финишное средство
- 5 кг

**detergente
finitura protettiva
5 kg**



RIP1485

Detergente de acabado
protector - 5 kg

Détergent Finition
Protectrice - 5 kg

Ready-to-Use
SCARPAVAPOR
Detergent - 1 liter

Моющее средство
SCARPAVAPOR
(готово к
использов.) - 1 л

**detergente
SCARPAVAPOR
pronto 1 lt**



RIP1489

Detergente
SCARPAVAPOR listo
para usar - 1 litro

Détergent
SCARPAVAPOR Prêt à
l'Emploi - 1 lt

Pre-treatment
Detergent
SCARPAVAPOR - 1

Средство для
предварительной
обработки
SCARPAVAPOR - 1 л

**detergente
pretrattante
SCARPAVAPOR 1 lt**



RIP1490

Detergente
pretratante
SCARPAVAPOR - 1

Détergent
Prétraitement
SCARPAVAPOR - 1 lt

1 liter Descaler -
dilute 1:5

Средство против
накипи 1 л -
разбавить 1:5

**anticalcare 1 lt
da diluire 1:5**



RIP1491

Antical 1 litro - diluir
1:5

Anticalcaire 1 lt -
diluer 1:5

External and Wheel
Pre-wash Detergent
- 5kg

Средство для
предварительной
мойки наружных
поверхностей и колес
- 5 кг

**detergente per
prelavaggio
esterno e cerchi
5 kg**



RIP1501

Detergente para
prelavado exterior y
llantas - 5 kg

Détergent pour Pré-
Lavage Extérieur et
Jantes - 5kg

codici

RIP1502



detergente per lavaggio moto e scooter 5 kg

Motorcycle and Scooter Wash Detergent - 5kg

Моющее средство для мотоциклов и скутеров - 5 кг

Detergente para lavado de motos y scooters - 5 kg

Détergent pour Lavage de Motos et Scooters - 5kg

RIP1503



detergente protettivo per cruscotti pelle e plastica 5 kg

Protective Detergent for Dashboards, Leather, and Plastic

Защитное средство для панелей, кожи и пластика - 5 кг

Detergente protector para salpicaderos, cuero y plástico - 5 kg

Détergent Protecteur pour Tableaux de Bord, Cuir et Plastique - 5kg

RIP1504



detergente sigillante protettivo ultrabrillante per carrozzeria 5 kg

Sealing Protective Ultra-Bright Detergent for Car Body - 5kg

Средство для ухода за кузовом автомобиля с ультра блеском - 5 кг

Detergente sellador protector ultrabrillante para carrocerías - 5 kg

Détergent Scellant Protecteur Ultra Brillant pour Carrosserie - 5kg

RIP1505



detergente speciale enzimatico per interni 5 kg

Enzymatic Special Interior Cleaner - 5kg

Специальное энзимное моющее средство для обивки - 5 кг

Detergente especial enzimático para interiores - 5 kg

Détergent Spécial Enzymatique pour Intérieurs - 5kg

RIP1506



detergente igienizzante enzimatico 5 kg

Enzymatic Sanitizing Detergent - 5kg

Энзимное средство для санитарной обработки - 5 кг

Detergente igienizzante enzimático - 5 kg

Détergent Hygiénisant Enzymatique - 5 KG

RIP1507



detergente schiumoso per esterni auto 5 kg

Foamy Detergent for Car Exterior - 5kg

Пенообразующее моющее средство для наружных поверхностей автомобиля - 5 кг

Detergente espumoso para exteriores de autos - 5 kg

Détergent Mousseux pour Extérieurs de Voitures - 5kg

Degreaser Detergent
for Mechanical Parts
- 5kg

Обезжиривающее
средство для
механических
деталей - 5 кг

**detergente
sgrassante per
parti meccaniche
5 kg**



codici

RIP1509

Detergente
desengrasante para
piezas mecánicas - 5 kg

Détergent Dégraissant
pour Pièces
Mécaniques - 5kg

Concentrated
Sanitizing Detergent
- 1 liter

Моющее средство
для санитарной
обработки
(концентрат) - 1 л

**detergente
igienizzante
concentrato 1 lt**



RIP1510

Detergente
higienizante
concentrado - 1 litro

Détergent Hygiénisant
Concentré - 1 LT

Concentrated
Hydrogen Peroxide-
based Sanitizer - 5.7kg
to be diluted to 3%

Дезсредство на основе
концентрированной
перекиси водорода - 5,7
кг для разбавления до 3%

**sanificante a
base di perossido
di idrogeno
concentrato 5,7
kg (diluire al 3%)**



RIP1511

Sanitzante a base de
peróxido de hidrógeno
concentrado - 5.7 kg
para diluir al 3%

Désinfectant à base de
Peroxyde d'Hydrogène
Concentré - 5,7 kg
à diluer à 3%

VOC-Free Sanitizing
Liquid for Nebulizers

Жидкое средство
для санитарной
обработки

**liquido
igienizzante
VOC FREE per
nebulizzatori**



RIP1519

Líquido desinfectante
VOC-FREE para
nebulizadores

Liquide Assainissant
VOC-FREE Pour
Nébulisateurs

Spray Bottle with
Triangular Flask

Спрей с
треугольным
флаконом

**spruzzino
con flacone
triangolare**



RIP5188

Pulverizador con
botella triangular

Pulvérisateur avec
Flacon Triangulaire

nebulizzatori nebulizers nebulizadores nebuliseurs небулайзеры

codici

CVK36N



**nebulizzatore a
vapore**

steam Nebulizer

Распылитель паром

Nebulizador de vapor

Nébuliseur à Vapeur

CVK53



**nebulizzatore ad
aria**

Air Nebulizer

*Распылитель
воздухом*

Nebulizador de aire

Nébuliseur d'Air

CVK53S



**nebulizzatore
ad aria per
SANIBLASTER**

*Air Nebulizer for
SANIBLASTER*

*Распылитель
воздухом для
SANIBLASTER*

*Nebulizador de aire
para SANIBLASTER*

*Nébuliseur d'Air pour
SANIBLASTER*

CVK37N



**nebulizzatore
aspirazione e
vapore**

*Vacuum and steam
Nebulizer*

*Распылитель паром
с аспирацией*

*Nebulizador de
aspiración y vapor*

*Nébuliseur Aspiration
et Vapeur*

RIP1506



portaflaconi

Bottle Holder

*Держатель для
флаконов*

Porta-botellas

Porte-Flacons

COP2001



**flacone
nebulizzatore
vapore**

*steam Nebulizer
Bottle*

*Флакон для
распылителя паром*

*Botella nebulizadora
de vapor*

*Flacon Nébuliseur à
Vapeur*

bocchette di aspirazione e vapore



vacuum and steam nozzles

boquillas de aspiracion y vapor

buses d'aspiration et de vapeur

аксессуары для подачи
пара и аспирации

codici

CVK01



**tubo flex
aspirazione per
CVK11 - 3 m**

*CVK11 Vacuum Flex
Tube - L 3 m*

*Гибкий шланг для
аспирации для
CVK11 - L 3 м*

*Tubo flexible de
aspiración para
CVK11 - L 3 m*

*Tuyau flexible
d'aspiration pour
CVK11 - Longueur 3 m*

CVK01D



**tubo flex
aspirazione per
CVK11 - 4 m**

*CVK11 Vacuum Flex
Tube - L 4 m*

*Гибкий шланг для
аспирации для
CVK11 - L 4 м*

*Tubo flexible de
aspiración para
CVK11 - L 4 m*

*Tuyau flexible
d'aspiration pour CVK11
- Longueur 4 m*

CVK01B



**tubo flex
aspirazione per
CVK11 - 6 m**

*CVK11 Vacuum Flex
Tube - L 6 m*

*Гибкий шланг для
аспирации для
CVK11 - L 6 м*

*Tubo flexible de
aspiración para
CVK11 - L 6 m*

*Tuyau flexible
d'aspiration pour CVK11
- Longueur 6 m*

CVK11



**turbo spazzola
aspirazione**

Turbo Vacuum Brush

*Насадка -
турбощетка для
аспирации*

*Turbospazzola de
aspiración*

*Turbo brosse
d'aspiration*

CVE



**lancia estrazione
Ø 36 mm**

*Ø 36 mm Extraction
Lance*

*Насадка для
аспирации Ø 36 mm*

*Lanza de extracción Ø
36 mm*

*Lance d'extraction Ø
36 mm*

CVEB



**lancia iniezione
/ estrazione per
moquette
280 mm**

*Injection/Extraction
Lance for 280 mm
Carpet*

*Насадка для подачи
пара и аспирации
280 мм*

*Lanza de inyección/
extracción para
moquetas 280 mm*

*Lance d'injection/
extraction pour
moquette 280 mm*

Extraction Brush for Radiators

Вытяжная щетка для чистки калориферов

spazzola estrazione per caloriferi



codici

CVD

Cepillo de extracción para radiadores

Brosse d'extraction pour radiateurs

Ø 36 mm Black Moplen Brush

Щетка из черного моллена Ø 36 mm

pennello Ø 36 mm in moplen nero



CVF

Pincel Ø 36 mm en moplen negro

Pinseau diamètre Ø 36 mm en moplen noir

Ø 26 mm steam/ Vacuum Lance with Accessories Holder

Насадка-держатель для аксессуаров пар/ всасывание Ø 26 mm

lancia porta accessori aspirazione / vapore Ø 26 mm



CVA

Lanza porta-accesorios de aspiración/vapor Ø 26 mm

Lance porte-accessoires d'aspiration/vapeur Ø 26 mm

Injection/Extraction Lance with Brush liter

Насадка для подачи пара/аспирации с щеткой

lancia iniezione / estrazione con spazzolino



CVAB

Lanza de inyección/ extracción con cepillo litro

Lance d'injection/ extraction avec brosse litro

Chewing Gum Removal steam/ Vacuum Nozzle

Насадка для удаления жевательной резинки пар/

bocchetta aspirazione vapore per estrazione chewing gum



CVAC

Boquilla de aspiración/vapor para eliminación de chicles

Buse d'aspiration/ vapeur pour enlever les chewing-gums

110mm Rubber Vacuum Nozzle

Насадка для аспирации 110мм - резина

bocchetta aspirazione 110 mm in gomma



CVCT

Boquilla de aspiración 110mm - goma

Buse d'aspiration 110 mm - en caoutchouc

codici

CVCS



bocchetta aspirazione 110 mm con setole

110mm Vacuum Nozzle with Bristles

Насадка для аспирации 110мм с ворсом

Boquilla de aspiración 110mm con cerdas

Buse d'aspiration 110 mm avec des soies

CVC



bocchetta aspirazione 140 mm per tappezzerie

140 mm Upholstery Vacuum Nozzle

Насадка для аспирации для обивки - L 140мм

Boquilla de aspiración para tapicerías - L 140 mm

Buse d'aspiration pour tapisserie - Longueur 140 mm

CVK54



bocchetta iniezione / estrazione per pulizia caschi

Injection/Extraction Nozzle for Helmet Cleaning

Насадка для чистки шлемов подача пара/аспирация

Boquilla de inyección/extracción para limpieza de cascos

Buse d'injection/extraction pour le nettoyage des casques

CVK13



bocchetta iniezione / estrazione per tappezzeria

Injection/Extraction Nozzle for Upholstery

Насадка подача пара/аспирация, для обивки

Boquilla de inyección/extracción para tapicería

Buse d'injection/extraction pour tapisserie

CVK20S



bocchetta trasparente aspirazione / vapore L 11 cm

Transparent steam/ Vacuum Nozzle - L. 11cm

Прозрачная насадка для подачи пара/аспирации - L. 11см

Boquilla transparente de aspiración/vapor - L. 11cm

Buse transparente d'aspiration/vapeur - Longueur 11 cm

CVK20



bocchetta PRATIKA iniezione/ estrazione per aspirazione/ vapore acqua/ detergente

PRATIKA Injection/Extraction steam/ Vacuum/Water/ Detergent Nozzle
Boquilla PRATIKA de inyección/extracción de aspiración/vapor/

Насадка PRATIKA для подачи пара/воды/моющего средства и аспирации
Buse PRATIKA injection/extraction d'aspiration/vapeur/

PRATIKA Vacuum/
steam/Water Nozzle
for BF4000

Boquilla PRATIKA
de aspiración/vapor/
agua para BF4000

Насадка PRATIKA
для аспирации/
подачи пара/воды
для BF4000

Buse PRATIKA
d'aspiration/vapeur/
eau pour BF4000

**bocchetta
PRATIKA
aspirazione/
vapore acqua per
BF4000**

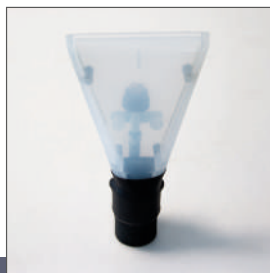

codici

CVK20G

Brass 30/80 Nozzle
for CVK20 Nozzle

Pulverizador de latón
30/80 para boquilla
CVK20

Форсунка
распылительная
латунная 30/80 для
насадки CVK20

Pulvérisateur en
laiton 30/80 pour buse
CVK20

**spruzzino di
ottone 30/80 mm
per bocchetta
CVK20**

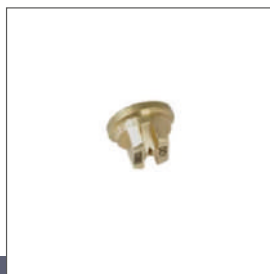

COD5001

3/8" Plastic Collar for
CVK20 Nozzle

Tuerca de plástico
3/8" para boquilla
CVK20

Гайка пластиковая
3/8" для насадки
CVK20

Vague en plastique
3/8" pour buse CVK20

**ghiera 3/8"
in plastica per
bocchetta CVK20**

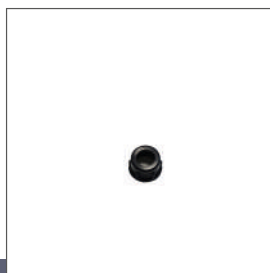

RIP2005

150 mm steam/
Windshield Wiper
Nozzle
liter

Boquilla
limpiaparabrisas de
aspiración/vapor 150
mm

Насадка для чистки
стекла, подача пара/
аспирация 150мм

Buse d'aspiration/
vapeur pour essuie-
glaces 150 mm

**bocchetta
tergivetro
aspirazione/
vapore 150 mm**



CVG1

150 mm PVC Bristle
Windshield Wiper
Frame for CVG

Marco de
limpiaparabrisas de
150 mm para CVG1 -
Cerdas de PVC

Вкладыш для чистки
стекла 150 мм для
CVG1 - щетина из
ПВХ

Cadre pour essuie-
glaces 150 mm pour
CVG1 - Soies en PVC

**telaio tergivetro
in gomma 150
mm per CVG1**

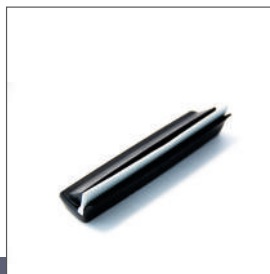

CVG2

150 mm Hard PVC
Bristle Windshield
Wiper Frame for CVG1

Marco de
limpiaparabrisas de
150 mm para CVG1 -
Cerdas de PVC rígidas

Вкладыш для чистки
стекла 150 мм для
CVG1 щетина из ПВХ

Cadre pour essuie-
glaces 150 mm pour
CVG1 - Soies en PVC
rigide

**telaio tergivetro
150 mm per
CVG1
setole in PVC**



CVG3

codici

CVG3B



**telaio tergivetro
150 mm per
CVG1
setole in PVC
dure**

*150mm Hard PVC
Bristle Windshield
Wiper Frame for CVG1*

*Вкладыш для чистки
стекла 150 мм для
CVG1 - жесткая
щетина из ПВХ*

*Marco de
limpiaparabrisas de
150mm para CVG1 -
Cerdas de PVC rígidas*

*Cadre pour essuie-
glaces 150 mm pour
CVG1 - Soies en PVC
rigide*

CVG4



**spazzola
rettangolare con
setole in ottone -
peli di animali**

*Rectangular Brush
with Brass Bristles for
Pet Hair Removal*

*Прямоугольная
щетка с латунной
щетинкой для
удаления шерсти
животных*

*Cepillo rectangular
con cerdas de latón
para la eliminación de
pelos de animales*

*Brosse rectangulaire
avec soies en laiton
pour éliminer les poils
d'animaux*

CVK71



**spazzola
aspirazione/
vapore per
teglie da forno
-setole in ottone**

*Kitchen Oven steam/
Vacuum Brush with
Brass Bristles*

*Щетка для
асpirации/подачи
пара - щетина из
латуни*

*Cepillo de aspiración/
vapor para hornos y
bandejas - cerdas de
latón*

*Brosse d'aspiration/
vapeur pour les
cuisines - Soies en
laiton*

CVG



**bocchetta
tergivetro
aspirazione/
vapore
250 mm**

*250mm steam/
Windshield Wiper
Nozzle*

*Насадка для чистки
стекла, подача пара/
асpirация 250мм*

*Boquilla
limpiaparabrisas de
aspiración/vapor
250mm*

*Buse d'aspiration/
vapeur pour essuie-
glaces 250 mm*

CVH



**bocchetta
aspirazione/
vapore
300 mm**

*300 mm steam/
Vacuum Nozzle*

*Насадка для подачи
пара/асpirации 300
мм*

*Boquilla de
aspiración/vapor 300
mm*

*Buse d'aspiration/
vapeur 300 mm*

CVM



**telaio 300 mm
con pattini**

*300 mm Frame with
Sliders*

*Вкладыш PATTINI 300
мм для насадки CVH*

*Marco de 300 mm con
patines*

*Cadre 300 mm avec
patins*

300 mm Frame with Bristles

Вкладыш 300 мм со щетиной для насадки CVH

telaio 300 mm con setole



codici

CVL

Marco de 300 mm con cerdas

Cadre 300 mm avec soies

300 mm Rubber Frame

Вкладыш резиновый 300 мм для насадки CVH

telaio 300 mm in gomma



CVI

Marco de goma de 300 mm

Cadre en caoutchouc 300 mm

Ø 13 mm Steam cell with bristles

Камера паровая Ø 13 мм со щетиной

camera vapore Ø 13 mm setolata



CVHC

Cámara de vapor Ø.13 mm con cerdas

Buse à vapeur Ø 13 mm avec soies

400 mm Injection/Extraction Nozzle for Floors

Насадка для чистки полов, подача/аспирация 400 мм

bocchetta iniezione/estrazione pavimenti 400 mm



CVH2

Boquilla de inyección/extracción para suelos 400 mm

Buse d'injection/extraction pour les sols 400 mm

400 mm Slider Frame

Вкладыш PATTINI 400 мм для насадки CVH2

telaio pattini 400 mm



CVM2

Marco de patines de 400 mm

Cadre patins 400 mm

400 mm Rubber Frame

Вкладыш 400 мм со щетиной для насадки CVH2

telaio setole 400 mm



CVL2

Marco de goma de 400 mm

Cadre en caoutchouc 400 mm

codici

CVI2



**telaio gomma
400 mm**

400 mm Rubber
Frame

Вкладыш резиновый
400мм для насадки
CVH2

Marco de goma de
400 mm

Cadre en caoutchouc
400 mm

CVH2C



**camera vapore Ø
12 mm setolata**

Ø 12 mm Steam cell
with bristles

Камера паровая Ø
12mm со щетиной

Cámara de vapor Ø
12mm con cerdas

Buse à vapeur Ø 12
mm avec soies

CVCG



**bocchetta
estrazione per
chewing gum**

Chewing Gum
Extraction Nozzle

Насадка для
удаления
жевательной
резинки

Boquilla de extracción
para eliminación de
chicles

Buse d'extraction pour
les chewing-gums

CVC2



**bocchetta in
gomma per
aspirazione 80
mm**

80 mm Rubber
Vacuum Nozzle

Насадка резиновая
для аспирации 80 мм

80mm Rubber
Vacuum Nozzle

Buse en caoutchouc
pour aspiration 80 mm

CVT



**bocchetta
iniezione/
estrazione per
pavimenti
240 mm**

240 mm Injection/
Extraction Nozzle for
Floors

Насадка для чистки
полов подача/
аспирация 240 мм

Boquilla de inyección/
extracción para suelos
240 mm

Buse d'injection/
extraction pour les
sols 240 mm

CVTA



**telaio gomma
con setole
aspirazione/
vapore**

Rubber Frame with
Bristles for steam/
Vacuum

Вкладыш резиновый
со щетиной для CVT

Marco de goma y con
cerdas de aspiración/
vapor

Cadre en caoutchouc
et soies pour
aspiration/vapeur

*Injection/Extraction
Carpet Cleaner - L 1 m*

*Насадка для чистки
ковролина пар/
аспирация, длина 1
метр*

**lava moquette
iniezione/
estrazione
L 1 m**



codici

CVK49

*Lavamoquetas de
inyección/extracción
- L 1 m*

*Injecteur/extracteur pour le
nettoyage des moquettes -
Longueur 1 m*

Rays Vacuum Brush

*Насадка-щетка
вытяжная*

**brusca aspiratrice
a raggi**



CVK25

*Aspiradora de radios
bruscos*

*Brosse aspiratrice à
rayons*

Accessory Bag

*Сумка для
аксессуаров*

borsa accessori



CC129

Bolsa de accesorios

Sac d'accessoires

*rubber washer Ø
15x9,5x1,5 mm*

*резиновая шайба Ø
15x9,5x1,5 мм*

**rondella gomma
Ø 15x9,5x1,5 mm**



RIP2006

*arandela de goma Ø
15x9,5x1,5 mm*

*rondelle en
caoutchouc Ø
15x9,5x1,5 mm*

codici

--

--

--

--

--

--



**impugnature,
lance e pistole**



handles, lances, and guns

empunaduras, lanzas y pistolas

poignees, lances et pistolets

шланги, насадки и пистолеты

codici

KIT5003

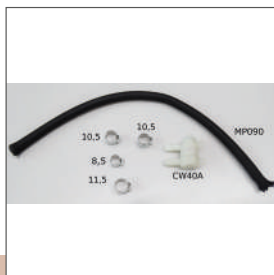

**kit ricambi
rubinetto parallelo
impugnatura
meccanica CVK21**

*CVK21 Mechanical
Handle Spare Parts
Kit*

*Комплект запасных
частей для
параллельного
крана, ручка*

*Kit de repuestos para
grifo paralelo y asa
mecánica CVK21*

*Kit de pièces de
rechange pour robinet
parallèle poignée
mécanique CVK21*

CVK21V



**impugnatura
aspirazione /
vapore
3 m**

*Vacuum/steam
Handle 3 m*

*Шланг пар/
аспирация, дл. 3 м*

*Asa de aspiración/
vapor 3 m*

*Poignée d'aspiration/
vapeur 3 m*

CVK21



**impugnatura
aspirazione /
vapore
4 m**

*Vacuum/steam
Handle 4 m*

*Шланг пар/
аспирация, дл. 4 м*

*Asa de aspiración/
vapor 4 m*

*Poignée d'aspiration/
vapeur 4 m*

CVK21C



**impugnatura
aspirazione /
vapore
5 m**

*Vacuum/steam
Handle - L 5 m*

*Шланг пар/
аспирация, дл. 5 м*

*Asa de aspiración/
vapor - L 5 m*

*Poignée d'aspiration/
vapeur - Longueur 5 m*

CVK21B



**impugnatura
aspirazione /
vapore
8 m**

*Vacuum/steam
Handle - L 8 m*

*Шланг пар/
аспирация, дл. 8 м*

*Asa de aspiración/
vapor - L 8 m*

*Poignée d'aspiration/
vapeur - Longueur 8 m*

CV97



**leva per PRATIKA
/ maniglia
CARWASH**

*Pratika/Carwash
Handle Lever*

*Рукоятка для Pratika/
ручка Carwash*

*Palanca para Pratika/
Manilla de Carwash*

*Levier pour pratique/
poignée Carwash*

Counterposed Faucet
Spare Parts Kit

Комплект запасных
частей для
противоположного
крана

kit de repuestos para
grifo contrapuesto

Kit de pièces de
rechange pour robinet
à contre-poids

**kit ricambi
rubinetto
contrapposto**



codici

KIT5002

Faucet and Gasket
Spare Parts Kit

Комплект запасных
частей краны и
прокладки

kit de repuestos para
grifos y juntas

Kit de pièces de
rechange pour
robinets et joints

**kit ricambi
rubinetti e
guarnizioni**

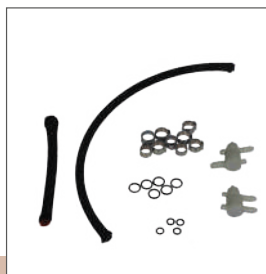

KIT5001

Gasket Kit:
MGOR x 6 +
CVPOR x 4

Набор уплотнений:
MGOR x 6 +
CVPOR x 4

Kit de juntas:
MGOR x 6 +
CVPOR x 4

Kit de joints :
MGOR x 6 +
CVPOR x 4

**kit guarnizioni:
MGOR x6
CVPOR x4**

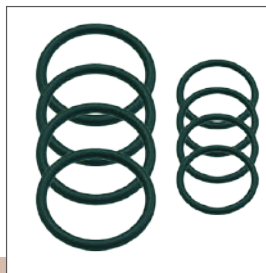

KIT5006

OR Kit Bieffe
5,28x1,78 EPDM
Peroxide

OR Комплект Bieffe
5,28x1,78 EPDM

Kit OR Bieffe
5,28x1,78 EPDM
Perossidico

Kit OR Bieffe
5,28x1,78 EPDM
peroxyde

**OR kit BIEFFE
5,28x1,78 mm
EPDM
perossidico**

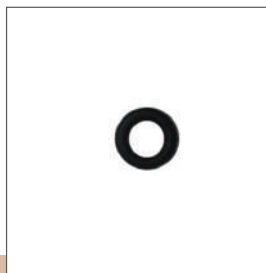

CVPOR

Emilio steam/Vacuum
Handle - L 2 m

Шланг пар/
аспирация для
Emilio, дл. 2 м

Asa de aspiración/
vapor Emilio - L 2 m

Poignée d'aspiration/
vapeur Emilio -
Longueur 2 m

**impugnatura
aspirazione/
vapore EMILIO
2 m**



CVP

Emilio steam/Vacuum
Handle - L 3 m

Шланг пар/
аспирация для Emilio,
дл. 3 м

Asa de aspiración/
vapor Emilio - L 3 m

Poignée d'aspiration/
vapeur Emilio -
Longueur 3 m

**impugnatura
aspirazione/
vapore EMILIO
3 m**



CVP3

codici

CVPCV



impugnatura aspirazione / vapore rinforzata CLEAN VAPOR 2 m

Reinforced CLEAN VAPOR Vacuum Handle - L 2 m

Шланг пар/аспирация для CLEAN VAPOR, дл. 2 м

Asa de aspiración/vapor reforzada CLEAN VAPOR - L 2 m

Poignée d'aspiration/vapeur renforcée CLEAN VAPOR - Longueur 2 m

CVP3CV



impugnatura aspirazione / vapore rinforzata CLEAN VAPOR 3 m

CLEAN VAPOR steam/Vacuum Handle - L 3 m

Шланг пар/аспирация для CLEAN VAPOR, дл. 3 м

Asa de aspiración/vapor CLEAN VAPOR - L 3 m

Poignée d'aspiration/vapeur CLEAN VAPOR - Longueur 3 m

CVP5CV



impugnatura aspirazione / vapore rinforzata CLEAN VAPOR 5 m

CLEAN VAPOR steam/Vacuum Handle - 5 m

Шланг пар/аспирация для CLEAN VAPOR, дл. 5 м

Asa de aspiración/vapor CLEAN VAPOR - 5 m

Poignée d'aspiration/vapeur CLEAN VAPOR - Longueur 5 m

CVK21EB



impugnatura vapore / acqua calda / aspirazione 3 m

Hot Water/steam/Vacuum Handle - 3 m

Шланг пар/горячая вода/аспирация, дл. 3 м

Asa de vapor/agua caliente/aspiración - 3 m

Poignée vapeur/eau chaude/aspiration - 3 m

CVK21E



impugnatura vapore / acqua calda / aspirazione 4 m

Hot Water/steam/Vacuum Handle - 4 m

Шланг электрич. пар/горячая вода/аспирация, дл. 4 м

Asa de vapor/agua caliente/aspiración - 4 m

Poignée vapeur/eau chaude/aspiration - 4 m

CVK21EC



impugnatura vapore / acqua calda / aspirazione 5 m

Electric Hot Water/steam/Vacuum Handle - 5 m

Шланг электрич. пара/горячая вода/аспирация, длина 5 м

Asa eléctrica de vapor/agua caliente/aspiración - 5 m

Poignée électrique vapeur/eau chaude/aspiration - Longueur

Hot Water/steam/
Vacuum Handle - 8 m

Шланг электр.
пара/горячая вода/
аспирация, длина
8 м

**impugnatura
vapore /
acqua calda /
aspirazione 8 m**



codici

CVK21ED

Asa de vapor/agua
caliente/aspiración
- 8 m

Poignée vapeur/eau
chaude/aspiration - 8
m

Ø 35mm bent Vacuum
Handle with Valve

Переходник для
шланга изогнутый с
клапаном Ø 35 mm

**impugnatura
curva aspirazione
con valvola
Ø 35 mm**



RIP0706

Asa curva de
aspiración con válvula
Ø 35 mm

Poignée courbe
d'aspiration avec
valve Ø 35 mm

steam Flex Handle - L
2,5 m

Гибкий шланг для
подачи пара - 2,5 м

**impugnatura
vapore flex 2,5 m**



MGH04

Asa de vapor Flex - L
2,5 m

Poignée vapeur flex -
Longueur 2,5 m

Magic/Emilio/CLEAN
VAPOR steam Handle
2 m

Шланг для подачи
пара 2 м Magic/
Emilio/Clean Vapor

**impugnatura
vapore 2 m
MAGIC / EMILIO /
CLEAN VAPOR**



MGK01NW

Asa de vapor 2 m
Magic/Emilio/CLEAN
VAPOR

Poignée vapeur 2 m
Magic/Emilio/CLEAN
VAPOR

Emilio/Magic Vapor
steam Handle 3 m

Шланг для подачи
пара 3 м - Emilio/
Magic Vapor

**impugnatura
vapore 3 m
MAGIC VAPOR /
EMILIO**



MGK01E03P

Asa de vapor 3 m -
Emilio/Magic Vapor

Poignée vapeur 3 m -
Emilio/Magic Vapor

Emilio/Magic Vapor
steam Handle 5 m

Шланг для подачи
пара 5 м - Emilio/
Magic Vapor

**impugnatura
vapore 5 m
MAGIC VAPOR /
EMILIO**



MGK01E05P

Asa de vapor 5 m -
Emilio/Magic Vapor

Poignée vapeur 5 m -
Emilio/Magic Vapor

codici

MGK01E03



impugnatura vapore 3 m STEAM 3000 / CLEAN VAPOR

Steam 3000/CLEAN VAPOR steam Handle 3 m

Шланг для подачи пара 3 м, Steam 3000/CLEAN VAPOR

Asa de vapor 3 m - Steam 3000/CLEAN VAPOR

Poignée vapeur 3 m - Steam 3000/CLEAN VAPOR

MGK01E05



impugnatura vapore 5 m STEAM 3000 / CLEAN VAPOR

Steam 3000/CLEAN VAPOR steam Handle 5 m

Шланг для подачи пара 5 м, Steam 3000/CLEAN VAPOR

Asa de vapor 5 m - Steam 3000/CLEAN VAPOR

Poignée vapeur 5 m - Steam 3000/CLEAN VAPOR

MGK01M22



impugnatura meccanica vapore 2,5 m

Mechanical steam Handle - L 2,5 m

Шланг для подачи пара механический, длина 2,5 м

Asa de vapor mecánica - L 2,5 m

Poignée mécanique vapeur - Longueur 2,5 m

MGK01M21



impugnatura meccanica vapore 5 m

Mechanical steam Handle - L 5 m

Шланг для подачи пара механический, длина 5 м

Asa de vapor mecánica - L 5 m

Poignée mécanique vapeur - Longueur 5 m

MGK01M11



impugnatura meccanica vapore BIEFFE / spina 5 m per CARWASH

Bieffe Mechanical steam Handle without Plug - 5 m for

Шланг для подачи пара механический без разъема, длина 5 м для CARWASH

Asa de vapor Bieffe mecánica sin enchufe 5 m para CARWASH

Poignée vapeur Bieffe mécanique sans prise 5 m pour CARWASH

CVK21SC



impugnatura vapore / aspirazione 2m SCARPAVAPOR NO LIMITS

2m steam/ Vacuum Handle - SCARPAVAPOR No Limits/Plus

Шланг пар/аспирация 2m SCARPAVAPOR No Limits/Plus

Asa de vapor / aspiración 2m SCARPAVAPOR No Limits / Plus

Poignée vapeur/ aspiration 2m SCARPAVAPOR No Limits / Plus

3/4m 3/8f Fitting with Gasket for BF4000 steam Extension hose

Разъем 3/4 "папа" 3/8 "мама" с уплотн. для продления шланга BF4000

Conector 3/4m 3/8f con junta para extensión de tubo de

Raccord 3/4m 3/8f avec joint pour prolongateur de tuyau

raccordo 3/4 M 3/8 F con guarnizione per prolunga tubo vapore BF4000



codici

RIP2324

steam Extension

Удлинительные насадки для парового шланга

Extensión de vapor

Prolongateur de vapeur

prolunga vapore



MGK02N

steam/Detergent Extension hose 1m - Available up to 30 m

Удлинитель шланга пар/моющее средство 1 м – Под заказ до 30 м

Extensión de tubo de vapor/detergente 1m - A pedido hasta 30 m

Prolongateur de tuyau vapeur/détergent 1 m - Sur demande jusqu'à 30 m

prolunga tubo vapore / detergente 1 m (a richiesta fino a 30 m)



RIP0405

Steam extension hose 1m - Available up to 30 m on request

Удлинитель парового шланга 1 м – Под заказ до 30 м

Extension de tubo de vapor 1 m - Bajo pedido hasta 30 m

Prolongateur de tuyau vapeur 1 m - Sur demande jusqu'à 30 m

prolunga tubo vapore 1 m (a richiesta fino a 30 m)



RIP0408

8 m Extension hose for BF4000 steam Gun

Удлинитель парового шланга для BF4000 – 8 м

Extension de tubo de vapor para BF4000 - 8 m

Prolongateur de tuyau vapeur pour BF4000 - 8 m

prolunga tubo vapore per BIEFFE4000 8 m



RIP0421

10 m Extension hose for BF4000 steam Gun

Удлинитель парового шланга для BF4000 – 10 м

Extension de tubo de vapor para BF4000 - 10 m

Prolongateur de tuyau vapeur pour BF4000 - 10 m

prolunga tubo vapore per BIEFFE4000 10 m



RIP0422

codici

RIP0423



**prolunga tubo
vapore per
BIEFFE4000
15 m**

15 m Extension hose
for BF4000 steam
Gun

Удлинитель
парового шланга для
BF4000 – 15 м

Extension de tubo de
vapor para BF4000
- 15 m

Prolongateur de tuyau
vapeur pour BF4000
- 15 m

RIP0420



**tubo pistola
vapore con
raccordo per
BIEFFE4000 5 m**

5 m Tube with Fitting
for BF4000 steam
Gun

Шланг для парового
пистолета с
соединительным
штуцером для модели
BF4000 - 5 м

Tubo de pistola de
vapor con conector
para BF4000 - 5 m

Tuyau de pistolet
vapeur avec raccord
pour BF4000 - 5 m

RIP0424



**prolunga tubo
vapore per
BF4000 20 m**

20 m Extension hose
for BF4000 steam
Gun

Удлинитель
парового шланга
для BF4000 – 20 м

Extension de tubo de
vapor para BF4000 -
20 m

Prolongateur de tuyau
vapeur pour BF4000
- 20 m

RIP0425



**prolunga tubo
vapore per
BF4000 25 m**

25 m Extension hose
for BF4000 steam
Gun

Удлинитель
парового шланга
для BF4000 – 25 м

Extension de tubo de
vapor para BF4000 -
25 m

Prolongateur de tuyau
vapeur pour BF4000
- 25 m

RIP0426



**prolunga tubo
vapore per
BF4000 30 m**

30 m Extension hose
for BF4000 steam
Gun

Удлинитель
парового шланга для
BF4000 – 30 м

Extension de tubo de
vapor para BF4000 -
30 m

Prolongateur de tuyau
vapeur pour BF4000
- 30 m

CVO



**prolunga iniez/
esteraz c/ leva
L44 cm**

steam/vac extension
l44 cm

Удлиненная насадка
подача/всасывание
44 см

extensión de
inyección/extracción
c/palanca l44 cm

rallonge inject/
extract l44

Injection/Extraction
Extension 44 cm

Удлиненная насадка
подача/всасывание
44 см

Extensión de
inyección / extracción
44 cm

Prolongateur
d'injection/ extraction
44 cm

**prolunga
iniezione
estrazione 44 cm**



codici

CV0N

Extension Block with
Collar and Lever

Фиксатор
удлинителя с
кольцом и рычагом

Bloque de extensión
con abrazadera y
palanca

Bloc prolongateur
avec bague et levier

**blocco prolunga
ghiera e leva**



CV0-F

Extension Block with
Collar and Spring

Фиксатор
удлинителя с
кольцом и пружиной

Bloque de extensión
con abrazadera y
resorte

Bloc prolongateur
avec bague et ressort

**blocco prolunga
ghiera e molla**



CV0-M

45° Injection/
Extraction Extension -
L 30 cm "high"

Удлиненная насадка
подача/всасывание
45° - Длина 30 см
"вверх"

Extensión de
inyección / extracción
45° - L 30 cm "alto"

Prolongateur
d'injection/ extraction
45° - Longueur 30 cm

**prolunga
iniezione /
estrazione 45° 30
cm - alto**



CVK70A

45° Injection/
Extraction Extension -
L 30 cm "low"

Удлиненная насадка
подача/всасывание
45° - Длина 30 см
"вниз"

Extensión de
inyección / extracción
45° - L 30 cm "bajo"

Prolongateur
d'injection/ extraction
45° - Longueur 30 cm

**prolunga
iniezione /
estrazione 45° 30
cm - alto**



CVK70

Steel Injection/
Extraction Extension
- L 1m

Удлинитель
втяжно-вытяжной
из стали - длина 1 м

Extensión de
inyección / extracción
de acero - L 1m

Prolongateur
d'injection/ extraction
en acier - Longueur 1

**prolunga
iniezione /
estrazione in
acciaio**



CVK51

codici

RIP2337



**prolunga nero
per lancia
portaaccessori
asp/vap spv**

*black extension for
asp/vap spv accessory
holder wand*

*Черный удлинитель
для держателя
аксессуаров asp/vap
spv*

*extensión negra
para varita porta
accesorios asp/vap*

*Extension noire pour
baguette porte-
accessoires asp/vap*

RIP0401



**pistola meccanica
vapore/
detergente per
BF4000 / ECOWASH
/ CLEAN VAPOR
20 cm / tubo 8 m**

*Mechanical steam/
Detergent Gun for BF4000/
ECOWASH/CLEAN VAPOR
- L 20 cm - 8 m tube*

*Пистолет с механическим
управлением для подачи
пара и моющего средства
для BF4000/ECOWASH/
CLEAN VAPOR - длина 20
см, шланг 8 м*

*Pistola mecánica de vapor/
detergente para BF4000/
ECOWASH/CLEAN VAPOR
- L 20 cm - tubo 8 m*

*Pistolet mécanique vapeur/
détergent pour BF4000/
ECOWASH/CLEAN VAPOR
- L 20 cm - tuyau de 8 m*

RIP0402



**pistola meccanica
vapore/
detergente per
BF4000 / ECOWASH
/ CLEAN VAPOR
50 cm / tubo 8 m**

*Mechanical steam/
Detergent Gun for BF4000/
ECOWASH/CLEAN VAPOR
- L 50 cm - 8 m tube*

*Пистолет с механическим
управлением для подачи
пара и моющего средства
для BF4000/ECOWASH/
CLEAN VAPOR - длина 20
см, шланг 8 м*

*Pistola mecánica de vapor/
detergente para BF4000/
ECOWASH/CLEAN VAPOR
- L 50 cm - tubo 8 m*

*Pistolet mécanique vapeur/
détergent pour BF4000/
ECOWASH/CLEAN VAPOR
- L 50 cm - tuyau de 8 m*

RIP0403



**pistola meccanica
vapore/
detergente per
BF4000 / ECOWASH
/ CLEAN VAPOR
130 cm / tubo 8 m**

*Mechanical steam/
Detergent Gun for BF4000/
ECOWASH/CLEAN VAPOR
- L 130 cm - 8 m tube*

*Пистолет с механическим
управлением для подачи
пара и моющего средства
для BF4000/ECOWASH/
CLEAN VAPOR - длина 20
см, шланг 8 м*

*Pistola mecánica de vapor/
detergente para BF4000/
ECOWASH/CLEAN VAPOR
- L 130 cm - tubo 8 m*

*Pistolet mécanique vapeur/
détergent pour BF4000/
ECOWASH/CLEAN VAPOR
- L 130 cm - tuyau de 8 m*

RIP2304



**pistola vapore
BF4000 con
lancia all.
200 mm**

*BF4000 steam Gun
with 200 mm Lance*

*Паровой пистолет
BF4000 с насадкой
200 мм*

*Pistola de vapor
BF4000 con lanza de
200 mm*

*Pistolet vapeur
BF4000 avec lance
200 mm*

RIP0406



**pistola vapore
meccanica con
tubo 8 m**

*Mechanical steam
Gun with 8 m Tube*

*Механический
паровой пистолет с
шлангом 8 м*

*Pistola mecánica de
vapor con tubo de 8 m*

*Pistolet vapeur
mécanique avec tuyau
de 8 m*

Mechanical steam
Gun with 10 m Tube

Механический
паровой пистолет с
шлангом 10 м

**pistola vapore
meccanica con
tubo 10 m**



codici

RIP0413

Pistola mecánica de
vapor con tubo de
10 m

Pistolet vapeur
mécanique avec tuyau
de 10 m

Trigger f/steam gun

Ручка парового
пистолета Bieffe

**grilletto pistola
vapore BIEFFE**



COP5000_01

gatillo de la pistola de
vapor Bieffe

Declencheur
pistolet vapeur

Steam gun /
sanitizing detergent
Magic Vapor SANI

Пистолет для
поддачи пара /
дезинфицирующей
жидкости Magic
Vapor SANI

**pistola vapore
/ liquido
igenizzante
MAGIC VAPOR
SANI**



MGK01ESA

Pistola de vapor /
liquido desinfectante
Magic Vapor SANI

Pistolet vapeur /
liquide désinfectant
Magic Vapor SANI

1-Way steam Gun
- Spina Magic

Паровой пистолет
1 выход
- Spina Magic

**pistola vapore
1 via con SPINA
MAGIC**



KITMG01

Pistola de vapor de
1 vía- Spina Magic

Pistolet vapeur 1 voie
- Spina Magic

2-Way Flat Nozzle
steam Gun

Паровой пистолет
2 выхода с плоским
наконечником

**pistola vapore
beccuccio piatto
2 vie**



AR252B

Pistola de vapor con
boquilla plana de 2
vías

Pistolet vapeur bec
plat 2 voies

2-Way Round Nozzle
steam Gun

Паровой пистолет
2 выхода с круглым
наконечником

**pistola vapore
beccuccio tondo
2 vie**

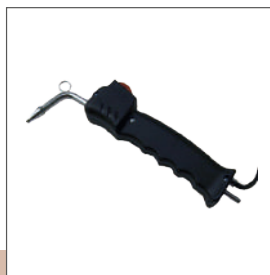

AR252V

Pistola de vapor con
boquilla redonda de
2 vías

Pistolet vapeur bec
rond 2 voies

codici

AR25



**pistola vapore
beccuccio tondo
1 via**

*1-Way Round Nozzle
steam Gun*

*Паровой пистолет
с круглым
наконечником 1
выход*

*Pistola de vapor con
boquilla redonda de
1 vía*

*Pistolet vapeur avec
bec rond 1 voie*

RIP0931



**pistola vapore
BIEFFE 1 via
VAPORDENT**

*Bieffe 1-Way
VAPORDENT steam
Gun*

*Пистолет для
подачи пара
BIEFFE с 1 выходом
VAPORDENT*

*Pistola de vapor de
1 vía VAPORDENT
Bieffe*

*Pistolet vapeur Bieffe
1 voie VAPORDENT*

RIP0922



**pistola vapore/
acqua calda
BIEFFE 2 vie
VAPORDENT**

*Bieffe 2-Way
VAPORDENT steam/
Hot Water Gun*

*Пистолет для
подачи пара/горячей
воды Bieffe 2 выхода
VAPORDENT*

*Pistola de vapor /
agua caliente de 2
vías VAPORDENT*

*Pistolet vapeur/eau
chaude Bieffe 2 voies
VAPORDENT*

COP5000



**pistola vapore
BIEFFE 2019 solo
plastiche 2019
VAPORDENT**

*Bieffe 2019 steam
Gun for Plastics Only*

*Паровой пистолет
Bieffe 2019 только
пластиковый корпус*

*Pistola de vapor
Bieffe 2019 solo
plástico*

*Pistolet vapeur Bieffe
2019 en plastique
uniquement*

RIP0914



**pistola vapore /
detergente
G-SCARPAVAPOR /
NO LIMITS / PLUS**

*G-shaped steam/
Detergent Gun -
SCARPAVAPOR/No
Limits/Plus*

*Пистолет пар/
моющее средство G
- SCARPAVAPOR/No
Limits/Plus*

*Pistola de vapor
/detergente G -
SCARPAVAPOR /No
Limits / Plus*

*Pistolet vapeur/
détergent G -
SCARPAVAPOR/No
Limits/Plus*

MGK10B



**pistola vapore
/ acqua elettrica
per ECOWASH L
4 m**

*Electric steam/Hot
Water/Vacuum Gun
for Ecowash - L 4 m*

*Пистолет для
подачи пара и воды
с электрическим
управлением для
Ecowash – Длина 4 м*

*Pistola de vapor /
agua eléctrica para
Ecowash - L 4 m*

*Pistolet électrique
vapeur/eau chaude
pour Ecowash - L 4 m*

ECOWASH steam/
Detergent Gun

Пистолет пар/
моющее средство
ECOWASH

**pistola vapore
/ detergente
ECOWASH**



codici

CVK57

Pistola de vapor
/ detergente
ECOWASH

Pistolet vapeur/
détergent ECOWASH

F-shaped Protective
Finish Gun -
SCARPAVAPOR No
Limits

Пистолет для
нанесения финишного
покрытия F -
SCARPAVAPOR No
Limits

**pistola finitura
protettiva F -
SCARPAVAPOR NO
LIMITS**



RIP0906

Pistola de acabado
protector F -
SCARPAVAPOR No
Limits

Pistolet finition
protectrice F -
SCARPAVAPOR No
Limits

E-shaped Foam
Detergent Brush -
SCARPAVAPOR No
Limits

Щетка для нанесения
пенного средства
E - SCARPAVAPOR No
Limits

**spazzola schiuma
detergente E -
SCARPA VAPOR
NO LIMITS**



RIP0915

Cepillo de espuma
limpiadora E -
SCARPAVAPOR No
Limits

Brosse mousse
détergente E -
SCARPAVAPOR No
Limits

kit sandblasting
nozzle with hose

Комплект сопла
для пескоструйной
обработки с
шлангом

**kit testa
sabbiante**



RIP7006

kit boquilla chorreado
de arena con
manguera

kit embout sablage
avec tuyau

steam Brush
Connection

Соединительная
муфта для паровых
насадок

**raccordo per
spazzole vapore**



MGK03N

Conector para cepillos
de vapor

Raccord pour brosses
à vapeur

codici

AR313



**ugello
intercambiabile
piatto**

*Interchangeable Flat
Nozzle* *Сменное сопло
плоское*

*Boquilla
intercambiabile plana* *Embouts
interchangeables
plats*

AR312



**ugello
intercambiabile
tondo per pistola
AR25**

*Interchangeable
Round Nozzle for
AR25 Gun* *Сменное сопло
круглое для
пистолета AR25*

*Boquilla intercambiabile
redonda para pistola
AR25* *Embouts
interchangeables ronds
pour pistolet AR25*

RIP5226



**ugello /
beccuccio piatto
cromato M10
VAPORDENT**

*Chromed M10
VAPORDENT Flat
Nozzle/Beak* *Жиклер/
носик плоский
хромированный M10
VAPORDENT*

*Boquilla / boquilla
plana cromada M10
VAPORDENT* *Embouts plats
chromés en M10
VAPORDENT*

R655

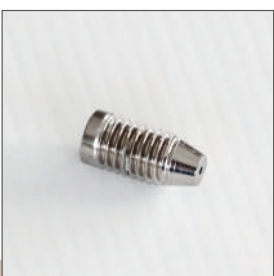

**punta di ottone
M6-L21**

*M6 Brass Tip - L 21
mm* *Болт латунный M6
- L 21 mm*

*Punta de latón M6 - L
21 mm* *Pointe en laiton M6 -
Longueur 21 mm*

COF5068



**supporto murale
pistola vapore
BIEFFE**

*Bieffe steam Gun Wall
Holder* *Настенный
держатель для
парового пистолета
Bieffe*

*Soporte de pared
para pistola de vapor
Bieffe* *Support mural pour
pistolet vapeur Bieffe*

Super Absorbent
White Microfiber
Cloth - 400x100mm -
RIP0801

Салфетка из
микрофибры белая
суперабсорбирующая -
400x100 мм - RIP0801

**panno
microfibra
assorbente
400x100 mm
per RIP0801**



codici

RIP0814

Paño de microfibra
súper absorbente
-400x100 mm -
RIP0801

Chiffon en microfibre
blanc ultra-absorbant -
400x100 mm - RIP0801

Hard Surfaces
Microfiber Cloth -
400x100mm - for
RIP0801

Салфетка из
микрофибры для
жестких поверхностей
- 400x100 мм - для
RIP0801

**panno
microfibra
superfici dure
400x100 mm
per RIP0801**



RIP0811

Paño de microfibra
superficies duras -
400x100 mm - para
RIP0801

Chiffon en microfibre
surfaces dures - 400x100
mm - pour RIP0801

Wood Microfiber Cloth
- 400x100mm - for
RIP0801

Салфетка из
микрофибры для
древесины - 400x100
мм - для RIP0801

**panno
microfibra per
legno
400x100 mm
per RIP0801**



RIP0813

Paño de microfibra
para madera - 400x100
mm - para RIP0801

Chiffon en microfibre
pour le bois - 400x100
mm - pour RIP0801

Abrasive/Hard
Surfaces Microfiber
Cloth - 400x100mm -
for RIP0801

Салфетка из микрофибры
для абразивных и
жестких поверхностей -
400x100 мм - для RIP0801

**panno
microfibra
abrasivo
superfici dure
400x100 mm
per RIP0801**

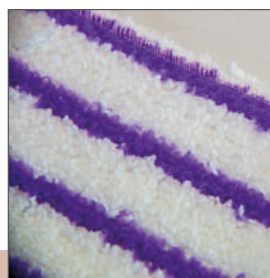

RIP0812

Paño de microfibra
abrasivas/superficies
duras - 400x100 mm - para
RIP0801

Chiffon en microfibre
abrasif/surfaces dures
- 400x100 mm - pour
RIP0801

Microfiber Cloth with
Hole 41x15 cm for
Mop

Салфетка из
микрофибры с
отверстием, 41x15
см, для мопа

**panno in
microfibra con
foro 41x15 cm
per MOP**



CVK39

pañó microfibra c/
agujero 41x15 cm
para mop

chiffon en microfibre
avec trou 41x15 cm
pour mop

350GSM Microfiber
Cloth - 400x400mm

Салфетка из
микрофибры 350GSM -
400x400 мм

**panno in
microfibra
350GSM
400x400 mm**



RIP6001

Paño de microfibra
350GSM - 400x400
mm

Chiffon en microfibre
350GSM - 400x400 mm
eau/détergent

codici

MGK04AS



**lancia iniezione
acqua calda
ARIASANA**

*Ariasana Hot Water
Injection Lance*

*Насадка для подачи
горячей воды
Ariasana*

*Lanza de inyección
de agua caliente
Ariasana*

*Lance d'injection eau
chaude Ariasana*

MGK04ASL



**lancia iniezione
acquacalda
ARIASANA
getto lungo**

*Ariasana Hot Water
Injection Lance Long
Jet*

*Насадка для подачи
горячей воды -
длинная струя
Ariasana*

*Lanza de inyección
de agua caliente
Ariasana de chorro*

*Lance d'injection eau
chaude Ariasana jet
long*

BFVAP001



**lancia
lavapavimenti a
vapore rotante**

*Rotating steam Floor
Cleaning Lance*

*Вращающаяся
паровая насадка-
очиститель для
пола*

*Lanza de vapor
rotativa para lavado
de suelos*

*Lance de lavage de
sols à vapeur rotative*

RIP2313



**lancia
nebulizzatrice
detergente 5 m**

*Detergent
Nebulization Lance -
L 5 m*

*Сопло для
распыления моющего
средства с шлангом
длиной 5 м*

*Lanza nebulizadora
de detergente - L 5 m*

*Lance nébuliseur
détergent - L 5 m*

CVES



**lancia
schiumogena
Ø 36 mm**

Ø 36 mm Foam Lance

*Насадка для пены,
Ø 36*

*Lanza espumadora
Ø 36*

Lance moussante Ø 36

MGK04N



lancia a vapore

steam Lance

Сопло паровое

Lanza de vapor

Lance vapeur

bent steam Lance *Сопло паровое изогнутое*

lancia a vapore curva



codici

MGK04NC

Lanza de vapor curva *Lance vapeur courbée*

Heavy steam Lance 45° - 300 mm *Паровое сопло "тяжелое" 45° - 300 мм*

lancia vapore PESANTE 45° - 300 mm



RIP2314

Lanza de vapor "pesada" 45° - 300 mm *Lance vapeur "lourde" 45° - 300 mm*

Straight "Heavy" steam Lance - 300 mm *Паровое сопло "тяжелое" прямое - 300 мм*

lancia vapore PESANTE dritta - 300 mm



RIP2315

Lanza de vapor "pesada" recta - 300 mm *Lance vapeur "lourde" droite - 300 mm*

Straight steam Lance - 200 mm *Паровое сопло прямое 200 мм*

lancia vapore dritta - 200 mm



RIP2310

Lanza de vapor recta 200 mm litro *Lance vapeur droite 200 mm*

Thermally Insulated bent steam Lance 700 mm *Паровое сопло термостойкое изогнутое - 700 мм*

lancia vapore atermica curva - 700 mm



RIP2321

Lanza de vapor curva atermal 700 mm *Lance vapeur courbée thermique 700 mm*

Thermally Insulated bent steam Lance 900 mm *Паровое сопло термостойкое изогнутое - 900 мм*

lancia vapore atermica curva - 900 mm



RIP2322

Lanza de vapor curva atermal 900 mm *Lance vapeur courbée thermique 900 mm*

codici

RIP2323



**lancia vapore
atermica curva -
1200 mm**

*Thermally Insulated
bent steam Lance
1200 mm*

*Паровое сопло
термостойкое
изогнутое 1200 мм*

*Lanza de vapor curva
atermal 1200 mm*

*Lance vapeur courbée
thermique 1200 mm*

MGK04BN



**lancia vapore
con prolunga in
ottone 19 cm**

*steam Lance - 19cm
Brass Extension*

*Сопло паровое
с латунным
удлинителем 19 см*

*Lanza de vapor -
extensión de latón de
19 cm*

*Lance vapeur -
rallonge en laiton 19
cm*

MGK04AN



**lancia vapore
curva con ugello
in ottone**

*bent steam Lance
with Brass Nozzle*

*Сопло паровое
изогнутое с
латунным
жиклером*

*Lanza de vapor curva
con boquilla de latón*

*Lance vapeur courbée
avec embout en laiton*

RIP0801



**spazzolone
a vapore
professionale
tubo 5 m**

*Professional steam
Brush - 5 m Tube*

*Щетка для чистки паром
ПРОФЕССИОНАЛЬНАЯ
Шланг 5 м*

*Cepillo de vapor
PROFESIONAL - Tubo
5 m*

*Balai vapeur
PROFESSIONNEL -
Tuyau de 5 m*

CVK30



**tubo iniezione
/ estrazione
per rimozione
chewing gum
1 m**

*Chewing Gum
Removal Injection/
Extraction Tube - L 1 m*

*Шланг всасывание/
подача пара для
удаления жвачки -
длина 1 м*

*Tubo de inyección
/ extracción para
eliminación de chicles
L 1 m*

*Tuyau d'injection/
extraction pour enlever
les chewing-gums
L 1 m*

AR319



**silicone spray
extra 500 ml**

*silicone extra spray
500 ml*

*силиконовый спрей
extra 500 мл*

*silicona extra en
spray 500 ml*

*spray silicone extra
500 ml*

accessory holder
spear asp/vap brass
tip spv

копье для держателя
аксессуаров
asp/vap латунный
наконечник spv

lanza porta accesorios
punta de latón asp/
vap spv

lance porte-accessoires
asp/vap pointe en
laiton spv

**lancia porta
accessori
asp/vap puntale
ottone spv**



codici

RIP2336



codici



spazzole e
spazzolini



brushes and small brushes

cepillos

brosses

щетки

codici

RIS1027



spazzola leva pelucchi BRUSH FOREVER

Brush Forever Lint Remover Brush

Щетка для удаления катышков "BRUSH FOREVER"

Cepillo Quitapelusas "BRUSH FOREVER" Cerdas de PVC rígidas

Brosse anti-peluches "BRUSH FOREVER" rigide

CVK106

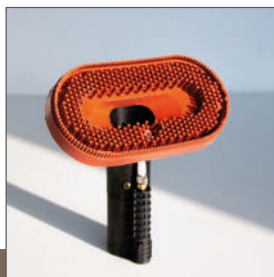

spazzola silicone iniezione/ estrazione antigraffio setole autopulenti

Silicone Injection/ Extraction Brush with Self-Cleaning Anti-

Щетка силиконовая подача/вытяжка, предотвращающая царапины

Cepillo de silicona para inyección/ extracción, cerdas

Brosse en silicone pour injection/extraction, avec des soies auto-

MGK07N



spazzola vapore rettangolare con setole

Rectangular steam Brush with Bristles

Щетка паровая прямоугольная с щетиной

Cepillo de vapor rectangular con cerdas

Brosse rectangulaire à vapeur avec des soies

MGK07NV



spazzola vapore rettangolare con velcro

Rectangular steam Brush with Velcro

Щетка паровая прямоугольная с липучкой

Cepillo de vapor rectangular con velcro

Brosse rectangulaire à vapeur avec velcro

RIP6101



panno in microfibra velcrato, 330x150 mm bianco per spazzole rettangolari

Velcro Microfiber Cloth, 330x150 mm, White for Rectangular Brushes

Ткань белая из микрофибры на липучке, размер 330x150 мм, для прямоугольных щеток

Paño de microfibra con velcro, 330x150 mm, blanco para cepillos rectangulares

Chiffon en microfibre velcro, 330x150 mm, blanc pour brosses rectangulaires

MGK05N



tergivetro vapore

steam Windshield Wiper

Насадка для чистки стекол паром

Limpiador de cristales a vapor

Essuie-vitre à vapeur

Triangular steam
Brush with Bristles

Щетка паровая
треугольная с
щетинной

spazzola vapore
triangolare con
setole



codici

MGK06N

Cepillo de vapor
triangular con cerdas

Brosse triangulaire à
vapeur avec des soies

Triangular steam
Brush with Velcro

Щетка паровая
треугольная с
липучкой

spazzola vapore
triangolare con
velcro



MGK06NV

Cepillo de vapor
triangular con velcro

Brosse triangulaire à
vapeur avec velcro

Velcro Triangular
Microfiber Cloth,
White for Triangular
Brushes

Ткань белая из
микрофибры
на липучке, для
треугольных щеток

panno
triangolare
microfibra
velcrato, bianco
per spazzole
triangolari



RIP6102

Paño triangular de
microfibra con velcro,
blanco para cepillos
triangulares

Chiffon triangulaire
en microfibre, velcro,
blanc pour brosses
triangulaires

Triangular Brush for
CVA

Треугольная щетка
для CVA

spazzolino
triangolare per
CVA

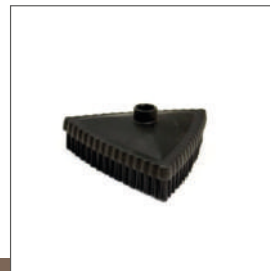

CVB4

Cepillo Triangular para
CVA

Brosse triangulaire
pour CVA

Ø 20 mm steam Brush
- CRINE Bristles

Паровая щетка
Ø 20 мм - щетина
натуральная

spazzolino
vapore Ø 20 mm
setole in crine

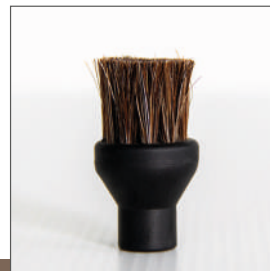

RIP5154

Cepillo a vapor
Ø 20 mm - Cerdas de
CRIN

Brosse vapeur
Ø 20 mm - Soies en
crine

Silicone Cap for steam
Injection into Barrels

Силиконовая
заглушка для
парового инжектора
для бочек

tappo in silicone
per iniezione
vapore per botti

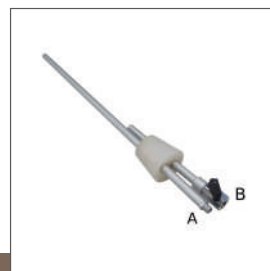

RIP0611

Tapón de Silicona para
Inyección de Vapor en
Barriles

Bouchon en silicone
pour injection vapeur
pour fûts

codici

CVB



**spazzolino
Ø 20 mm per CVA
setole in pvc**

Ø 20 mm Brush for
CVA - PVC Bristles

Щетка Ø 20 мм для
CVA - Щетинки из
ПВХ

Cepillo Ø 20 mm para
CVA - Cerdas de PVC

Brosse Ø 20 mm pour
CVA - Soies en PVC

CVB2



**spazzolino
Ø 20 mm per CVA
setole in acciaio**

Ø 20 mm Brush for
CVA - Steel Bristles

Щетка Ø 20 мм для
CVA - Щетинки из
стали

Cepillo Ø 20 mm para
CVA - Cerdas de acero

Brosse Ø 20 mm pour
CVA - Soies en acier

CVB3

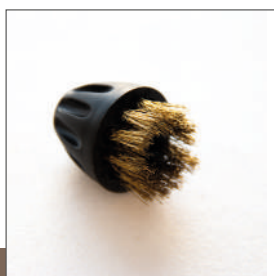

**spazzolino
Ø 20 mm per
CVACsetole in
ottone**

Ø 20 mm Brush for
CVA - Brass Bristles

Щетка Ø 20 мм для
CVA - Щетинки из
латуни

Cepillo Ø 20 mm para
CVA - Cerdas de latón

Brosse Ø 20 mm pour
CVA - Soies en laiton

RIP5222

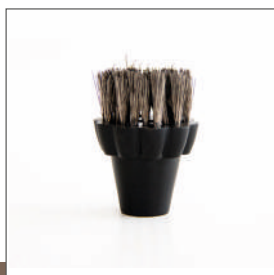

**spazzolino
Ø 25 mm M10
setole in acciaio**

Ø 25 mm M10 Brush -
Steel Bristles

Щетка Ø 25 мм M10 -
Щетинки из стали

Cepillo Ø 25 mm M10
- Cerdas de acero

Brosse Ø 25 mm M10 -
Soies en acier

RIP5223



**spazzolino
Ø 25 mm M10
setole in ottone**

Ø 25 mm M10 Brush -
Brass Bristles

Щетка Ø 25 мм M10 -
Щетинки из латуни

Cepillo Ø 25 mm M10
- Cerdas de latón

Brosse Ø 25 mm M10
- Soies en laiton

RIP5224



**spazzolino
Ø 25 mm M10
setole in acciaio
pekalon**

Ø 25 mm M10 Brush -
Pekalon Bristles

Щетка Ø 25 мм
M10 - Щетинки из
пекалона

Cepillo Ø 25 mm M10
- Cerdas de pekalon

Brosse Ø 25 mm M10 -
Soies en pekalon

Ø 25 mm M10 Brush - Natural Bristles
 Щетка Ø 25 мм M10 - Натуральные щетинки

Cepillo Ø 25 mm M10 - Cerdas naturales
 Brosse Ø 25 mm M10 - Soies naturelles

**spazzolino
 Ø 25 mm M10
 setole naturali**



codici

RIP5225

Ø 25 mm M10 Brush - PVC Bristles
 Щетка Ø 25 мм - Щетинки из ПВХ

Cepillo Ø 25 mm M10 - Cerdas de PVC
 Brosse Ø 25 mm M10 - Soies en PVC

**spazzolino
 Ø 25 mm M10
 setole in pvc**



RIP5221

bent Ø 26 mm Brush NEW CRINE
 Щетка согнутая Ø 26 мм, с натуральной щетиной

Cepillo curvo nuevo Ø 26 mm de cerdas naturales
 Brosse courbe Ø 26 mm NEW CRINE

**spazzolino
 Ø 26 mm new
 curvo crine**



MGLNF

bent Ø 26 mm Brush for MGK04N Steam Lance - Nylon Bristles
 Щетка Ø 26 мм для паровой насадки MGK04N - щетина из нейлона

Cepillo Ø 26 mm curvo para lanza de vapor MGK04N - Cerdas de nylon
 Brosse courbée Ø 26 mm pour lance à vapeur MGK04N - Soies en nylon

**spazzolino Ø 26
 mm curvo per
 lancia vapore
 MGK04N setole
 nylon**



MGLND

Ø 26 mm Brush for MGK04N Steam Lance - Brass Bristles
 Щетка Ø 26 мм для MGK04N - щетина из латуни

Cepillo Ø 26 mm para MGK04N - Cerdas de latón
 Brosse Ø 26 mm pour MGK04N - Soies en laiton

**spazzolino Ø 26
 mm per MGK04N
 setole in ottone**



MGLNE

Ø 28 mm Brush for MGK04NC Steam Lance - Brass Bristles
 Щетка Ø 28 мм для паровой насадки MGK04NC - щетина из латуни

Cepillo Ø 28 mm para lanza de vapor MGK04NC - Cerdas de latón
 Brosse Ø 28 mm pour lance à vapeur MGK04NC - Soies en laiton

**spazzolino Ø 28
 mm per lancia
 vapore MGK04NC
 setole in ottone**



MGLNB

codici

MGLNA

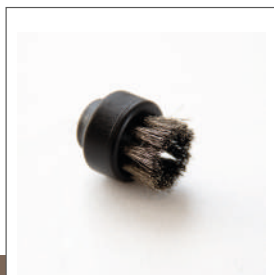

**spazzolino
Ø 28 mm per
MGK04NC setole
in acciaio**

Ø 28 mm Brush for
MGK04NC Steam
Lance - Steel Bristles

Щетка Ø 28 мм для
MGK04NC - щетина
из стали

Cepillo Ø 28 mm para
MGK04NC - Cerdas
de acero

Brosse Ø 28 mm pour
MGK04NC - Soies en
acier

MGLNC



**spazzolino
Ø 28 mm per
MGK04NC setole
in crine**

Ø 28 mm Brush for
MGK04NC Steam
Lance - CRINE

Щетка Ø 28 мм для
MGK04NC - щетина
натуральная

Cepillo Ø 28 mm para
MGK04NC - Cerdas
de cerdas naturales

Brosse Ø 28 mm pour
MGK04NC - Soies en
crin

MGLN



**spazzolino
Ø 28 mm per
MGK04NC setole
in nylon**

Ø 28 mm Brush for
MGK04NC Steam
Lance - Nylon Bristles

Щетка Ø 28 мм для
MGK04NC - щетина
из нейлона

Cepillo Ø 28 mm para
MGK04NC - Cerdas
de nylon

Brosse Ø 28 mm pour
MGK04NC - Soies en
nylon

MGM01



sturalavandini

Drain Cleaner

Фильтр-заглушка
для умывальника

Destapa-cañerías

Déboucheur de
canalisations

CVK31B



**spazzolino
Ø 60 mm setole
in ottone**

D60mm Brush - Brass
Bristles

Щетка диам. 60 мм -
щетина из латуни

Cepillo Diam. 60 -
Cerdas de latón

Brosse D60 - Soies en
laiton

CVK31C



**spazzolino
Ø 60 mm setole
in pvc**

D60mm Brush - PVC
Bristles

Щетка диам. 60 мм -
щетина из ПВХ

Cepillo Diam. 60 -
Cerdas de PVC

Brosse D60 - Soies en
PVC

Ø 60 mm Brush
- Stainless Steel
Bristles

Щетка Ø 60
мм - щетина из
нержавеющей
стали

**spazzolino
Ø 60 mm setole
inox**



codici

CVK31D

Cepillo Ø 60 mm
- Cerdas de acero
inoxidable

Brosse Ø 60 mm
- Soies en acier
inoxydable

Ø 60 mm Brush -
CRINE Bristles

Щетка Ø 60 мм
- натуральная
щетина

**spazzolino
Ø 60 mm 1/8 F
setole in crine**



CVK31S

Cepillo Ø 60 mm 1/8F
- Cerdas de cerdas
naturales

Brosse Ø 60 mm 1/8F -
Soies en CRIN

Ø 60 mm M10 Brush -
PVC Bristles

Щетка Ø 60 мм -
щетина из ПВХ

**spazzolino
Ø 60 mm M10
setole pvc**



RIP5114

Cepillo Ø 60 mm M10
- Cerdas de PVC

Brosse Ø 60 mm M10 -
Soies en PVC

Ø 60 mm Brush for
MGK04N - Steel
Bristles

Щетка Ø 60 мм для
MGK04N - щетина
из стали

**spazzolino
Ø 60 mm per
MGK04N setole in
acciaio**



MGD01

Cepillo Ø 60 mm para
MGK04N - Cerdas de
acero

Brosse Ø 60 mm pour
MGK04N - Soies en
acier

Ø 60 mm Brush for
MGK04N - Bronze
Bristles

Щетка Ø 60 мм для
MGK04N - щетина
из бронзы

**spazzolino
Ø 60 mm per
MGK04N setole in
bronzo**



MGD03

Cepillo Ø 60 mm para
MGK04N - Cerdas de
bronze

Brosse Ø 60 mm pour
MGK04N - Soies en
bronze

Ø 60 mm Brush
for MGK04N - PVC
Bristles

Щетка Ø 60 мм для
MGK04N - щетина
из ПВХ

**spazzolino
Ø 60 mm per
MGK04N setole in
pvc**



MGD02

Cepillo Ø 60 mm para
MGK04N - Cerdas de
PVC

Brosse Ø 60 mm pour
MGK04N - Soies en
PVC

codici

MGD04



**spazzolino
Ø 60 mm per
MGK04N setole
naturali**

Ø 60 mm Brush for
MGK04N - Natural
Bristles

Щетка Ø 60 мм для
MGK04N - щетина
натуральная

Cepillo Ø 60 mm para
MGK04N - Cerdas
naturales

Brosse Ø 60 mm pour
MGK04N - Soies
naturelles

RIP5174

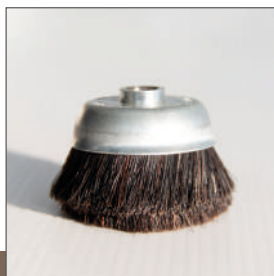

**spazzolino
Ø 60 mm 1/8 F
setole in crine**

Ø 60 mm 1/8F Brush -
CRINE Bristles

Щетка Ø 60 мм
1/8F - щетина
натуральная

Cepillo Ø 60 mm 1/8F
- Cerdas de cerdas
naturales

Brosse Ø 60 mm 1/8F -
Soies en crin

RIP5172



**spazzolino
Ø 60 mm 1/8 F
setole in ottone**

Ø 60 mm 1/8F Brush -
Brass Bristles

Щетка Ø 60 мм 1/8F
- щетина из латуни

Cepillo Ø 60 mm 1/8F
- Cerdas de latón

Brosse Ø 60 mm 1/8F -
Soies en laiton

RIP5173

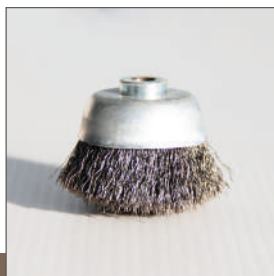

**spazzolino
Ø 60 mm 1/8 F
setole in inox**

Ø 60 mm 1/8F Brush
- Stainless Steel
Bristles

Щетка Ø 60 мм
1/8F - щетина из
нержавеющей стали

Cepillo Ø 60 mm
1/8F - Cerdas de acero
inoxidable

Brosse Ø 60 mm
1/8F - Soies en acier
inoxidable

MGD02N

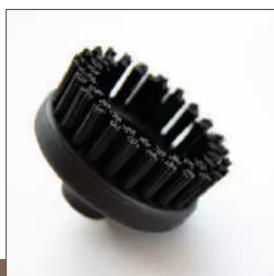

**spazzolino
Ø 65 mm setole
in pvc**

Ø 65 mm Brush - PVC
Bristles

Щетка Ø 65 мм -
щетина из ПВХ

Cepillo Ø 65 mm
Cerdas de PVC

Brosse Ø 65 mm Soies
en PVC

MGD04N



**spazzolino
Ø 65 mm per
MGK04NC setole
in crine**

Ø 65 mm Brush for
MGK04NC Steam
Lance - CRINE Bristles

Щетка Ø 65 мм для
MGK04NC - щетина
натуральная

Cepillo Ø 65 mm para
MGK04NC - Cerdas de
cerdas naturales

Brosse Ø 65 mm pour
MGK04NC - Soies en
crin

Ø 80 mm 1/8F Brush -
Brass Bristles

Щетка Ø 80 мм 1/8F
- щетина из латуни

**spazzolino
Ø 80 mm 1/8 F
setole in ottone**



codici

RIP5175

Cepillo Ø 80 mm 1/8F
- Cerdas de latón

Brosse Ø 80 mm 1/8F -
Soies en laiton

Ø 80 mm 1/8F Brush
- Stainless Steel
Bristles

Щетка Ø 80 мм
1/8F - щетина из
нержавеющей
стали

**spazzolino
Ø 80 mm 1/8 F
setole inox**



RIP5176

Cepillo Ø 80 mm
1/8F - Cerdas de acero
inoxidable

Brosse Ø 80 mm
1/8F - Soies en acier
inoxidable

Ø 60 mm 1/8F Plug
Brush - PVC Bristles

Щетка для паровой
насадки Ø 60 мм 1/8F
- щетина из ПВХ

**spazzolino
Ø 60 mm 1/8 F
per lancia setole
in pvc**

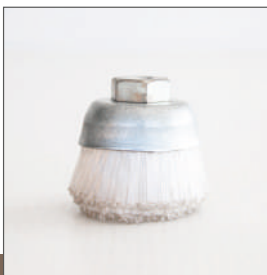

RIP5171

Cepillo para lanza Ø
60 mm 1/8F - Cerdas
de PVC

Brosse pour lance Ø
60 mm 1/8F - Soies en
PVC

Triangular Ø 70 mm
Brush - Steel Bristles

Треугольная щетка
Ø 70 мм - щетина из
стали

**spazzolino
Ø 60 mm
triangolare setole
in acciaio**



MGD11

Cepillo triangular Ø 70
mm - Cerdas de acero

Brosse triangulaire Ø
70 mm - Soies en acier

Triangular Ø 70 mm
Brush - Brass Bristles

Треугольная щетка
Ø 70 мм - щетина из
латуни

**spazzolino
Ø 60 mm
triangolare setole
in ottone**



MGD13

Cepillo triangular Ø 70
mm - Cerdas de latón

Brosse triangulaire
Ø 70 mm - Soies en
laiton

Triangular Ø 70 mm
Brush - PVC Bristles

Треугольная щетка
Ø 70 мм - щетина из
ПВХ

**spazzolino
Ø 60 mm
triangolare setole
in pvc**



MGD12

Cepillo triangular Ø 70
mm - Cerdas de PVC

Brosse triangulaire Ø
70 mm - Soies en PVC

codici

MGD15



spazzolino Ø 70 mm triangolare 1/8 F setole in crine

*Triangular Ø 70 mm
ATT.1/8F Brush -
CRINE Bristles*

*Треугольная
щетка Ø 70 мм
ATT.1/8F - щетина
натуральная*

*Cepillo Triangular Ø 70
mm ATT.1/8F - Cerdas
de CRIN*

*Brosse triangulaire
Ø 70 mm ATT.1/8F -
Soies en crin*

MGD14



spazzolino Ø 70 mm triangolare M10 setole in crine

*Triangular Ø 70 mm
M10 Brush - CRINE
Bristles*

*Треугольная
щетка Ø 70 мм
M10 - щетина
натуральная*

*Cepillo Triangular Ø
70 mm M10 - Cerdas
de CRIN*

*Brosse triangulaire
Ø 70 mm M10 - Soies
en crin*

MGK14N



spazzola pavimenti vapore mop 39x11 cm new

*steam mop floor brush
39x11 cm new*

*Щетка для пола
паровая швабра
39x11 cm новая*

*cepillo para pisos
trapeador a vapor
39x11 cm nuevo*

*balai à vapeur brosse
de sol 39x11 cm neuf*

accessori
asciugatura
e ozonizzazione



BIEFFE[®]
FARINELLI
GENERATORI DI VAPORE

drying and
ozonization accessories

accesorios de secado
y ozonizacion

accessoires de sechage
et d'ozonisation

аксессуары для сушки и
озонирования

codici

COB5001



**sacca 40x90 cm
con unità esterna
per ARIASANA**

*Outdoor Unit
Bag 40x90 cm for
ARIASANA*

*Чехол 40x90 см для
чистки наружного
блока с Ariasana*

*Saco 40x90 cm
para unidad externa
ARIASANA*

*Sac 40x90 cm pour
unité extérieure
ARIASANA*

COB5012



**sacca a
pavimento
con telaio per
ARIASANA**

*Floor Bag with Frame
for ARIASANA*

*Чехол напольный с
рамой для Ariasana*

*Bolsa a nivel del
suelo con marco para
ARIASANA*

*Sac de plancher avec
cadre pour ARIASANA*

RIP1312



**sacco asciuga
materasso
matrimoniale**

*Double Mattress
Drying Bag*

*Чехол для
сушки матраса
двухспального*

*Saco para secar
colchón matrimonial*

*Sac pour matelas
double séchant*

RIP1311



**sacco asciuga
materasso
singolo**

*Single Mattress
Drying Bag*

*Чехол для сушки
односпального
матраса*

*Saco para secar
colchón individual*

*Sac pour matelas
simple séchant*

CVK32



**sacco asciuga
sedili anteriori
con molla 1
pezzo**

*Front Seat Drying Bag
with Springs 1 piece*

*Чехол для сушки
передних сидений с
пружинами 1 шт*

*Saco para asientos
delanteros con
resortes, 1 pieza*

*Sac pour sièges
antérieur avec ressorts
1pc*

CVK62



**sacco asciuga
sedili posteriori
con molla per
CARFON**

*Rear Seat Drying
Bag with Springs for
CARFON*

*Чехол для сушки
задних сидений с
пружинами для
Carfon*

*Saco para asientos
traseros con resortes
para CARFON*

*Sac pour sièges
postérieure avec
ressorts pour CARFON*

Seats Ozonization
Bag

Чехол для
озонирования
сидений

**sacco
ozonizzazione
sedili**



codici

CVK32Z

Saco para
ozonización de
asientos

Sac pour ozonisation
de sièges

Rear Seats
Ozonization Bag
182x160 cm

Чехол для
озонирования задних
сидений 182x160 см

**sacco
ozonizzazione
sedili posteriori
182x160 cm**



CVK62CWZ

Saco para ozonización
de asientos traseros
182x160 cm

Sac pour ozonisation
de sièges postérieure
182x160 cm

Ozone Bag for
Helmets in Nylon

Чехол для
озонирования
шлема из нейлона

**sacco ozono per
casco in nylon**



RIP1301Z

Saco de ozono para
casco de nylon

Sac pour casque en
nylon ozoné

Ozone Bag for
Air Conditioner
Ozonization (Wall-
mounted Split)

Чехол для
озонирования
кондиционеров
(настенного сплита)

**sacco
ozonizzazione
condizionatori
(split a parete)**



CVK32D

Saco para ozonización
de acondicionadores
de aire (split a pared)

Sac pour ozonisation
de climatiseurs (split
mural)

Wall-mounted Split
Bag for ARIASANA

Чехол для чистки
настенного сплита
Ariasana

**sacco per split a
parete ARIASANA**



COB5011

Saco para split
a pared para
ARIASANA

Sac pour split mural
pour ARIASANA

Auto Floor Mat Drying
Cloth - 70x86 cm

Чехол для сушки
автомобильных
ковриков - 70x86 см

**telo asciuga
tappetini per
auto 70x86 cm**



RIP1305

Paño para secar
tapetes de
automóviles
70x86 cm

Tapis de séchage pour
tapis de voiture - 70x86
cm

codici

RIP1314



**telo asciuga
tappeto 400x300
cm piombato**

*Lead Weighted Cloth
for Drying Carpets
400x300 cm*

*Чехол для сушки
ковров 400x300 см с
весаами*

*pañõ para secar
tapetes 400x300 cm
plombado*

*tapis de séchage
400x300 cm plombé*

COF5009



**coppia croci per
asciuga tappetini**

*Pair of Crossbars for
Drying Floor Mats*

*Пара крестовин для
сушки ковриков*

*Par de cruces para
secar tapetes*

*Croix pour tapis de
séchage (paire)*

CVK61

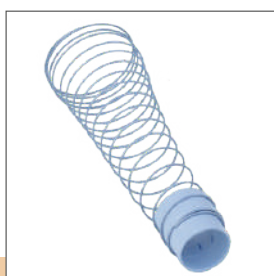

**diffusore ad
aria (molla e
manicotto)**

*Air Diffuser (Spring +
Sleeve)*

*Распределитель
воздуха (пружина +
втулка)*

*Difusor de aire
(muelle + manguito)*

*Diffuseur d'air
(Ressort + manchon)*

CVK10



**tubo flex getto
aria calda
350 cm**

*Hot Air Flex Nozzle
Tube - Length: 350 cm*

*Гибкий шланг для
горячего воздуха -
длина 350 см*

*Tuyau flexible pour jet
d'air chaud - L 350 cm*

*Tuyau flexible pour jet
d'air chaud - L 350 cm*

CVK10Z2



**tubo flex getto
aria calda
250 cm**

*Ozone Generator Flex
Tube - Length: 250 cm*

*Гибкий шланг для
озоногенератора -
длина 250 см*

*Tubo flexible para
generator de ozono -
L 250 cm*

*Tuyau flexible pour
générateur d'ozone - L
250 cm*

CVK10Z



**tubo flex per
generatore
ozono
70 cm**

*Ozone Generator Flex
Tube - Length: 70 cm*

*Гибкий шланг для
озоногенератора -
длина 70 см*

*Tubo flexible para
generator de ozono -
L 70 cm*

*Tuyau flexible pour
générateur d'ozone - L
70 cm*

codici

RIP5605

RIP5602

RIP5601

BF431D

BF431B

BF431A

CARFON OPEN
Hot Air FlexTube
Diameter: 110 mm
Length: 200 cm

Гибкий шланг для
горячего воздуха
CARFON OPEN диам.
110 мм, дл. 200 см

**tubo flex aria
calda open
110 mm / 200 cm**



tubo flexible aire
caliente carfon open
Diam.110 mm L. 200
cm

tuyau flexible d'air
chaud carfon open
Diam.110 mm L. 200
cm

Flexible Hot AirTube
120 cm Diameter: 50
mm for CARFON

Гибкий шланг для
горячего воздуха 120
см диам. 50 мм для
CARFON

**tubo aria calda
flessibile 50 mm/
175 cm
per CARFON**



Tubo de aire caliente
flexible de 120 cm de
diámetro 50 mm para
CARFON

Tuyau d'air chaud
flexible 120 cm
diam.50mm pour
CARFON

Flexible Hot AirTube
175 cm Diameter: 50
mm for CARFON

Гибкий шланг для
горячего воздуха 175
см диам. 50 мм для
CARFON

**tubo aria calda
flessibile 50 mm/
120 cm
per CARFON**



Tubo de aire caliente
flexible de 175 cm de
diámetro 50 mm para
CARFON

Tuyau d'air chaud
flexible 175 cm
diam.50mm pour
CARFON

1-gram/hour Ozone
Generator Kit 230V

Комплект
генератора озона 1
грамм/час 230 B

**kit generatore di
ozono
1 gr/ora
230V**



kit generador de
ozono 1 gramo/hora
230V

kit générateur d'ozone
1 gramme/heure 230V

BF431D

3.5-gram/hour Ozone
Generator Kit 12V

Комплект
генератора озона 3,5
грамма/час 12 B

**kit generatore di
ozono
3,5 gr/ora
12V**



kit generador de
ozono 3,5 gramos/
hora 12V

kit générateur d'ozone
3,5 grammes/heure
12V

BF431B

3.5-gram/hour Ozone
Generator Kit 230V

Комплект
генератора озона 3,5
грамма/час 230 B

**kit generatore di
ozono
3,5 gr/ora
230V**



kit generador de
ozono 3,5 gramos/
hora 230V

kit générateur d'ozone
3,5 grammes/heure
230V

BF431A

codici

BF431C



kit generatore di ozono 5 gr/ora 12V

5-gram/hour Ozone Generator Kit 12V

Комплект генератора озона 5 грамм/час 12 В

kit generador de ozono 5 gramos/hora 12V

kit générateur d'ozone 5 grammes/heure 12V

BF431E

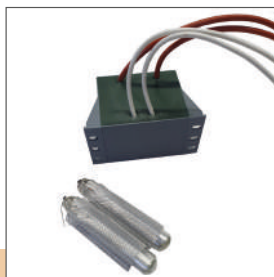

kit generatore di ozono scarico corona 230 V con trasformatore

CORONA Discharge Ozone Generator Kit 230V with Transformer

Комплект генератора озона с трансформатором 230 В

kit generador de ozono corona de descarga 230V con transformador

kit générateur d'ozone couronne de décharge 230V avec transformateur

COE4009



lampada generatore ozono dritta UV 9 W 230 V

Straight UV 9W 230V Ozone Generator Lamp

Прямая УФ-лампа для генератора озона 9 Вт 230 В

lámpara generador de ozono recta uv 9W 230V

lampe générateur d'ozone droite uv 9W 230V

AR318



lamapada generatore ozono 65 mm

65mm Ozone Generator Lamp

Лампа для генератора озона 65 мм

Lámpara generadora de ozono de 65 mm

Lampe générateur d'ozone 65 mm

COE4006



lamapada generatore di ozono con circuito

ozone generator lamp w/circuit board

лампа генератора озона с цепью

lámpara generadora de ozono c/circuito

lampe génératrice d'ozone avec circuit

**ricambi per
spazzatrici**



BIEFFE®
FARINELLI
GENERATORI DI VAPORE

sweeper spare parts

repuestos para barredoras

pieces detachees pour balayeuses

**запасные части для
подметальных машин**



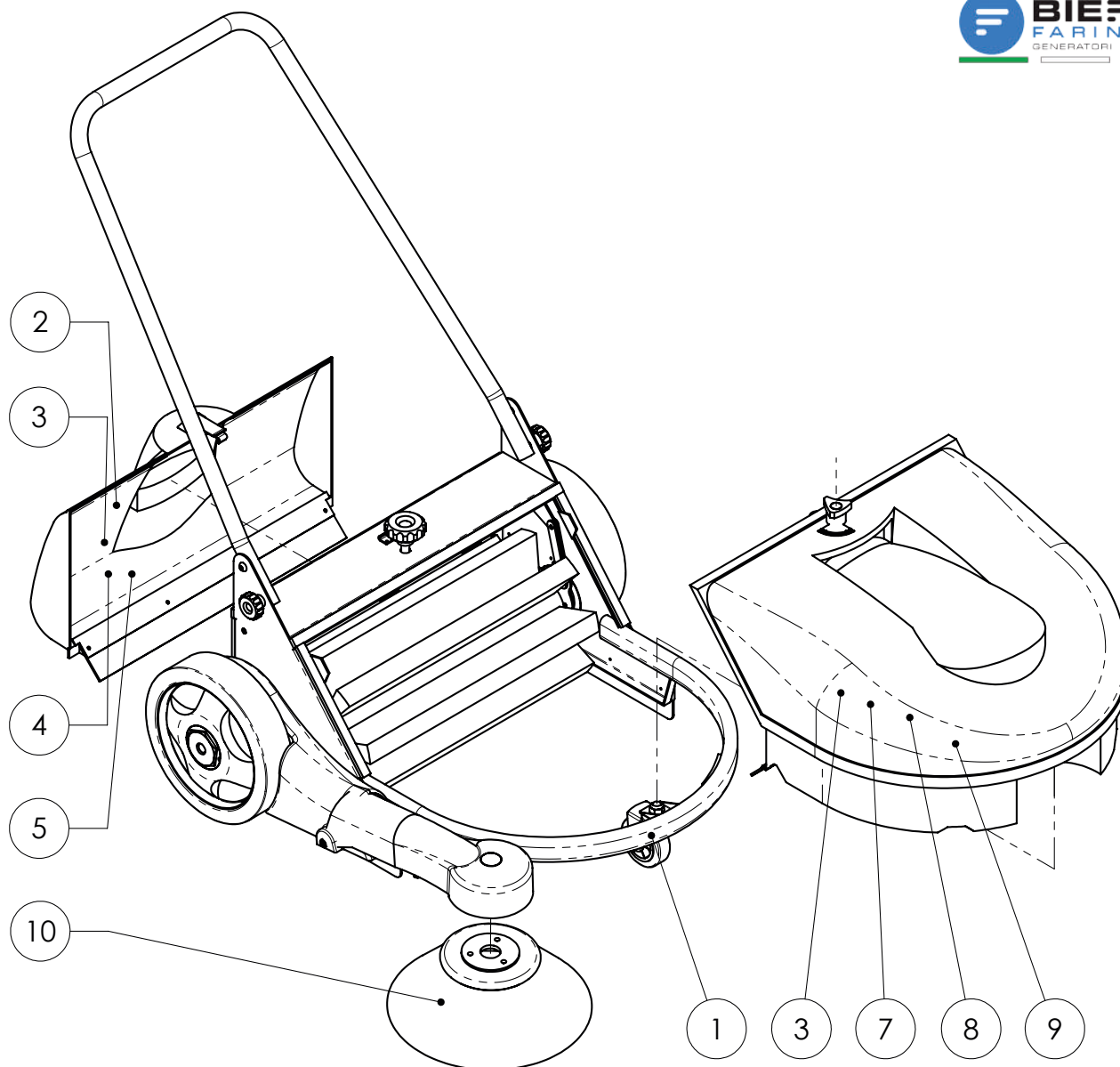

Pos.	Q.tà	Code	ITALIANO	ENGLISH	DEUTSCH	ESPAÑOL	FRANCAIS
1	1	2.067.07.001	Spazzatrice Premontata FLASH 650M	Preassembled Sweeper FLASH 650M	Vormontierung Kehrmaschine FLASH 650M	Preensamblado Barredora FLASH 650M	Préassemblé Balayeuse FLASH 650M
2	1	2.069.07.001	Cassetto posteriore FLASH 650M BLU	Back deposit FLASH 650M BLU	Rückseitiger Ablagerung FLASH 650M BLAU	Deposito trasero FLASH 650M AZUL	Dépôt arrier FLASH 650M BLEU
3	1	2.069.07.002	Cassetto anteriore FLASH 650M BLU	Front deposit FLASH 650M BLU	Forderer Ablagerung FLASH 650M BLAU	Deposito delantero FLASH 650M AZUL	Dépôt avant FLASH 650M BLEU
4	1	2.069.07.004	Cassetto posteriore FLASH 650M GIALLO	Back deposit FLASH 650M YELLOW	Rückseitiger Ablagerung FLASH 650M GELB	Deposito trasero FLASH 650M AMARILLO	Dépôt arrier FLASH 650M JAUNE
5	1	2.069.07.005	Cassetto posteriore FLASH 650M ROSSO	Back deposit FLASH 650M RED	Rückseitiger Ablagerung FLASH 650M ROT	Deposito trasero FLASH 650M ROJO	Dépôt avant FLASH 650M ROUGE
6	1	2.069.07.006	Cassetto anteriore FLASH 650M GIALLO	Front deposit FLASH 650M YELLOW	Rückseitiger Ablagerung FLASH 650M GELB	Deposito delantero FLASH 650M AMARILLO	Dépôt avant FLASH 650M JAUNE
7	1	2.069.07.007	Cassetto anteriore FLASH 650M ROSSO	Front deposit FLASH 650M RED	Rückseitiger Ablagerung FLASH 650M ROT	Deposito delantero FLASH 650M ROJO	Dépôt avant FLASH 650M ROUGE
8	1	2.069.07.009	Cassetto anteriore FLASH 650M VERDE	Front deposit FLASH 650M GREEN	Rückseitiger Ablagerung FLASH 650M GRÜN	Deposito delantero FLASH 650M VERDE	Dépôt avant FLASH 650M VERT
9	1	2.069.07.010	Cassetto posteriore FLASH 650M VERDE	Back deposit FLASH 650M GREEN	Rückseitiger Ablagerung FLASH 650M GRÜN	Deposito trasero FLASH 650M VERDE	Dépôt arrier FLASH 650M VERT
10	1	4.065.07.001	Spazzola Laterale PPL 0.50 ø300	Side brush PPL 0.50 ø300	Seitliche Bürste PPL 0.50 ø300	Cepillo lateral PPL 0.50 ø300	Brosse latérale PPL 0.50 ø300

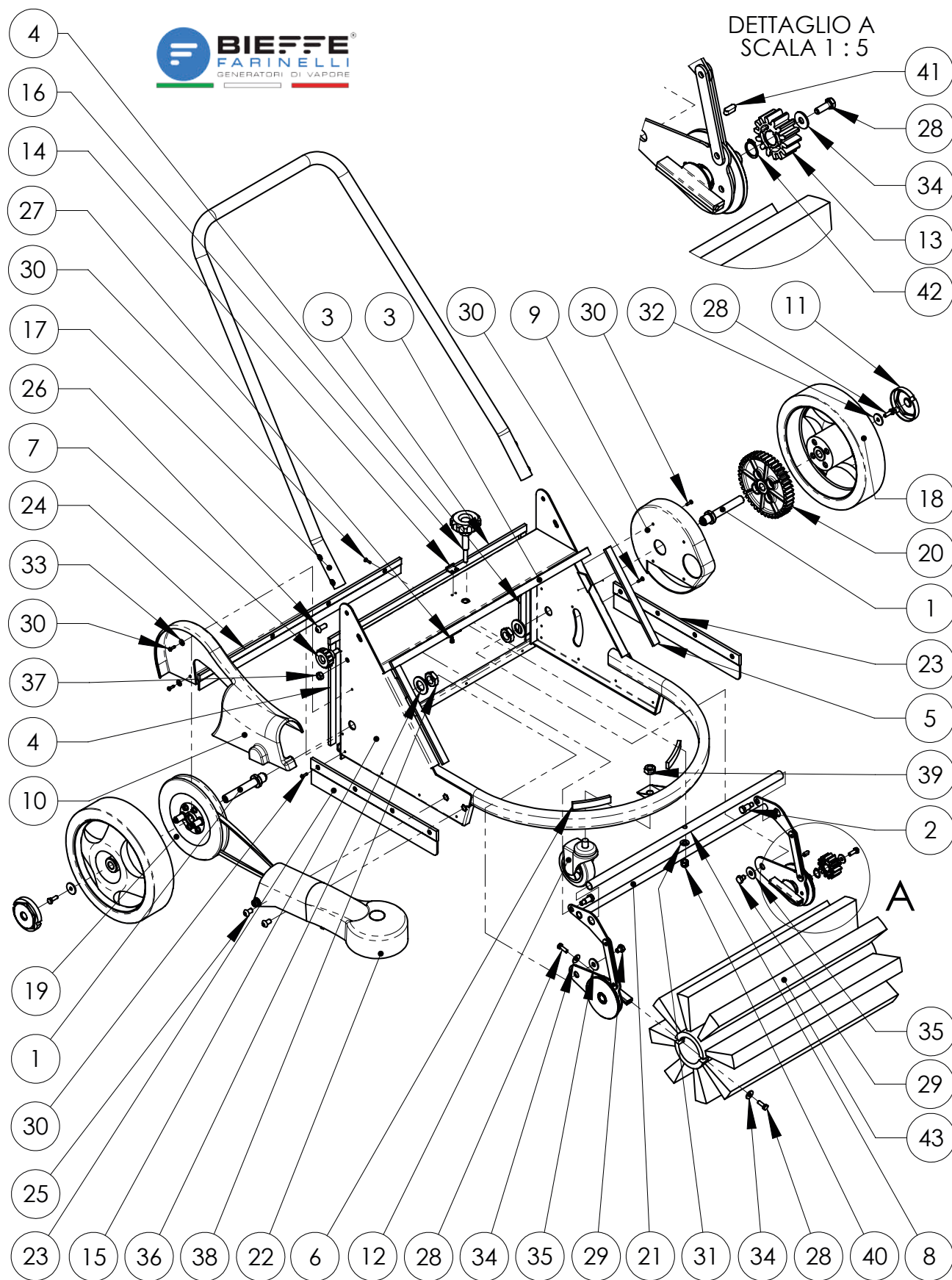

barredora Flash 650M | balayeuse Flash 650M | kermaschine Flash 650M

Pos.	Q.tà	Code	ITALIANO	ENGLISH	DEUTSCH	ESPAÑOL	FRANCAIS
1	2	1.002.27.003	Perno FLASH 650M	Pivot FLASH 650M	Stütze FLASH 650M	Gozne FLASH 650M	Pivot FLASH 650M
2	2	1.002.27.020	Perno	Pivot	Stütze	Gozne	Pivot
3	2	1.006.17.001	Guarnizione 15x6 L555	Gasket 15x6 L555	Dichtung 15x6 L555	Guarnición 15x6 L555	Garniture 15x6 L555
4	2	1.006.17.007	Guarnizione 15x6 L=245	Gasket 15x6 L=245	Dichtung 15x6 L=245	Guarnición 15x6 L=245	Garniture 15x6 L=245
5	2	1.006.17.008	Guarnizione 15x6 L=215	Gasket 15x6 L=215	Dichtung 15x6 L=215	Guarnición 15x6 L=215	Garniture 15x6 L=215
6	2	1.006.17.016	Guarnizione 15x6 L=80	Gasket 15x6 L=80	Dichtung 15x6 L=80	Guarnición 15x6 L=80	Garniture 15x6 L=80
7	2	1.021.04.004	Manopola M8x20	Knob M8x20	Griff M8x20	Pomo M8x20	Poignée M8x20
8	1	1.044.27.001	Tube L=540	Pipe L=540	Rohr L=540	Tube L=540	Tuyau L=540
9	1	1.075.07.001	Carter	Guard	Gehäuse	Cárter	Carter
10	1	1.075.07.002	Carter Protezione FLASH 650M	Front Cover FLASH 650M	Frontalmantel FLASH 650M	Carter frontal FLASH 650M	Capot anterior FLASH 650M
11	2	1.085.07.001	Coprizzo SR250 -RT-	Hub Cap SR250 -RT-	Nabe Haus SR250 -RT-	Casquillo del cubo SR250 -RT-	Enjoliveur de roue SR250 -RT-
12	1	1.086.07.002	Ruota girevole	Revolving wheel	Drehbares Rad	Rueda giratoria	Roue pivotante
13	1	1.122.07.001	Pignone Z14	Pinion Z14	Ritzel Z14	Piñón Z14	Pignon Z14
14	1	1.126.07.002	Gancio	Hook	Haken	Gancho	Crochet
15	1	2.015.07.002	Telaio FLASH 650M	Frame FLASH 650M	Rahmen FLASH 650M	Estructura FLASH 650M	Chassis FLASH 650M
16	1	2.039.07.001	Manopola regolazione spazzola FLASH 650M	Knob adjustment brush FLASH 650M	Knopf Anpassung Pinsel FLASH 650M	Perilla de ajuste de pincel FLASH 650M	Bouton de réglage de brosse FLASH 650M
17	1	2.042.07.001	Manico Flash 650M	Handle Flash 650M	Griff Flash 650M	Manija Flash 650M	Manche Flash 650M
18	2	2.054.07.001	Ruota ø250	Wheel ø250	Rad ø250	Rueda ø250	Roue ø250
19	1	2.061.07.001	Puleggia FLASH 650M	Pulley FLASH 650M	Riemenscheibe FLASH 650M	Polea FLASH 650M	Poulie FLASH 650M
20	1	2.062.07.001	Ingranaggio Z44	Gear Z44	Getriebe Z44	Engranaje Z44	Engrenage Z44
21	1	2.065.17.001	Bilanciere FLASH 650M	Balance wheel FLASH 650M	Schwinghebel FLASH 650M	Balancín FLASH 650M	Balancier FLASH 650M
22	1	2.066.07.001	Braccio FLASH 650M	Arm FLASH 650M	Arm FLASH 650M	Brazo FLASH 650M	Bras FLASH 650M
23	2	2.075.07.001	Fascia Laterale FLASH 650M	Side Band FLASH 650M	Seitliche Band FLASH 650M	Faja lateral FLASH 650M	Bande latérale FLASH 650M
24	1	2.075.07.002	Fascia Posteriore FLASH 650M	Back band FLASH 650M	Hinter Band FLASH 650M	Faja Posterior FLASH 650M	Bande Postérieure FLASH 650M
25	2	4.002.14.021	Vite M8x14 ISO7380	Screw M8x14 ISO7380	Schrauben M8x14 ISO7380	Tornillo M8x14 ISO7380	Vis M8x14 ISO7380
26	2	4.002.14.024	Vite M8x20 ISO7380	Screw M8x20 ISO7380	Schrauben M8x20 ISO7380	Tornillo M8x20 ISO7380	Vis M8x20 ISO7380
27	2	4.002.17.007	Vite M4x6 UNI 5931	Screw M4x6 UNI 5931	Schrauben M4x6 UNI 5931	Tornillo M4x6 UNI 5931	Vis M4x6 UNI 5931
28	7	4.002.44.003	Vite M6x18 UNI5739	Screw M6x18 UNI5739	Schrauben M6x18 UNI5739	Tornillo M6x18 UNI5739	Vis M6x18 UNI5739
29	2	4.002.47.005	Vite M8x10 UNI5739	Screw M8x10 UNI5739	Schrauben M8x10 UNI5739	Tornillo M8x10 UNI5739	Vis M8x10 UNI5739
30	17	4.002.94.022	Vite autofilettante 3.5x13 B	Self-tapping Screw 3.5x13 B	Selbschneidendeschraube 3.5x13 B	Tornillo autoblocante 3.5x13 B	Vis autofiletant 3.5x13 B
31	1	4.008.04.002	Rondella M8 UNI6592	Washer M8 UNI6592	Unterlegscheibe M8 UNI6592	Arandela M8 UNI6592	Rondelle M8 UNI6592
32	2	4.008.04.003	Rondella M6 UNI6593	Washer M6 UNI6593	Unterlegscheibe M6 UNI6593	Arandela M6 UNI6593	Rondelle M6 UNI6593
33	2	4.008.07.003	Rondella ø4xø12x1	Washer ø4xø12x1	Unterlegscheibe ø4xø12x1	Arandela ø4xø12x1	Rondelle ø4xø12x1
34	5	4.008.24.001	Rondella M6 UNI6593	Washer M6 UNI6593	Unterlegscheibe M6 UNI6593	Arandela M6 UNI6593	Rondelle M6 UNI6593
35	2	4.008.24.002	Rondella ø8.5x24x2.5 6593	Washer ø8.5x24x2.5 6593	Unterlegscheibe ø8.5x24x2.5 6593	Arandela ø8.5x24x2.5 6593	Rondelle ø8.5x24x2.5 6593
36	2	4.008.24.003	Rondella M20 UNI6592	Washer M20 UNI6592	Unterlegscheibe M20 UNI6592	Arandela M20 UNI6592	Rondelle M20 UNI6592
37	2	4.009.02.002	Dado M8 UNI5588	Nut M8 UNI5588	Mutter M8 UNI5588	Dado M8 UNI5588	Ecrou M8 UNI5588
38	2	4.009.07.001	Dado M18 UNI 5589-65 ZEG	Nut M18 UNI 5589-65 ZEG	Mutter M18 UNI 5589-65 ZEG	Dado M18 UNI 5589-65 ZEG	Ecrou M18 UNI 5589-65 ZEG
39	1	4.009.07.002	Dado M12 UNI 5588-65	Nut M12 UNI 5588-65	Mutter M12 UNI 5588-65	Dado M12 UNI 5588-65	Ecrou M12 UNI 5588-65
40	1	4.009.14.001	Dado M8 UNI7473	Nut M8 UNI7473	Mutter M8 UNI7473	Dado M8 UNI7473	Ecrou M8 UNI7473
41	1	4.021.07.001	Chiavetta A 5x5x14 UNI 6604	Key A 5x5x14 UNI 6604	Keil A 5x5x14 UNI 6604	Chaveta A 5x5x14 UNI 6604	Clavette A 5x5x14 UNI 6604
42	1	4.025.07.002	Seeger A15 UNI 7435-75	Seeger A15 UNI 7435-75	Seeger A15 UNI 7435-75	Seeger A15 UNI 7435-75	Seeger A15 UNI 7435-75
43	1	4.065.07.002	Spazzola ø240x490 (8x0.4)	Brush ø240x490 (8x0.4)	Bürste ø240x490 (8x0.4)	Cepillo ø240x490 (8x0.4)	Brosse ø240x490 (8x0.4)



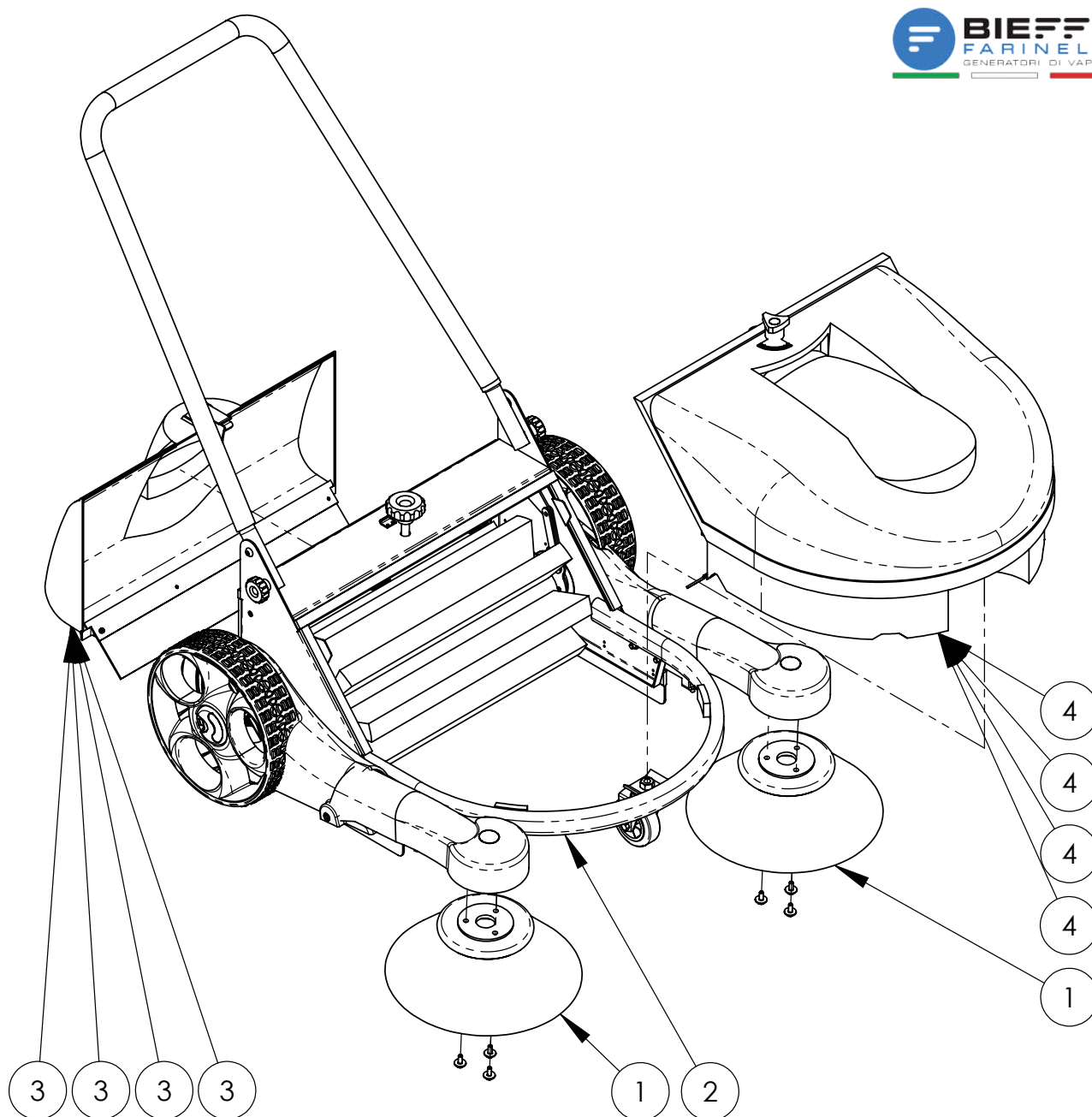

Pos.	Q.tà	Code	ITALIANO	ENGLISH	DEUTSCH	ESPAÑOL	FRANCAIS
1	2	4.065.07.001	Spazzola Laterale PPL 0.50 ø300	Side brush PPL 0.50 ø300	Seitliche Bürste PPL 0.50 ø300	Cepillo lateral PPL 0.50 ø300	Brosse latérale PPL 0.50 ø300
2	1	2.067.07.012	Spazzatrice Premontata Flash950M	Preassembled Sweeper Flash950M	Vormontierung Kehmaschine Flash950M	Preensamblado Barredora Flash950M	Préassemblé Balayeuse Flash950M
3	1	2.069.07.011	Cassetto posteriore blu FLASH 950M	Back deposit blue FLASH 950M	Rückseitiger Ablagerung blau FLASH 950M	Deposito trasero azul FLASH 950M	Dépôt arrier bleu FLASH 950M
3	1	2.069.07.013	Cassetto posteriore rosso Flash 950M	Back deposit red FLASH 950M	Rückseitiger Ablagerung rot FLASH 950M	Deposito trasero rojo FLASH 950M	Dépôt arrier rouge FLASH 950M
3	1	2.069.07.014	Cassetto posteriore giallo Flash 950M	Back deposit yellow FLASH 950M	Rückseitiger Ablagerung gelb FLASH 950M	Deposito trasero amarillo FLASH 950M	Dépôt arrier jaune FLASH 950M
3	1	2.069.07.015	Cassetto posteriore verde Flash 950M	Back deposit green FLASH 950M	Rückseitiger Ablagerung grün FLASH 950M	Deposito trasero verde FLASH 950M	Dépôt arrier vert FLASH 950M
4	1	2.069.07.012	Cassetto anteriore blu FLASH 950M	Front deposit blue FLASH 950M	Forderer Ablagerung blau FLASH 950M	Deposito delantero azul FLASH 950M	Dépôt avant bleu FLASH 950M
4	1	2.069.07.016	Cassetto Anteriore rosso Flash 950M	Front deposit red FLASH 950M	Forderer Ablagerung rot FLASH 950M	Deposito delantero rojo FLASH 950M	Dépôt avant rouge FLASH 950M
4	1	2.069.07.017	Cassetto Anteriore giallo Flash 950M	Front deposit yellow FLASH 950M	Forderer Ablagerung gelb FLASH 950M	Deposito delantero amarillo FLASH 950M	Dépôt avant jaune FLASH 950M
4	1	2.069.07.018	Cassetto Anteriore verde Flash 950M	Front deposit green FLASH 950M	Forderer Ablagerung grün FLASH 950M	Deposito delantero verde FLASH 950M	Dépôt avant vert FLASH 950M

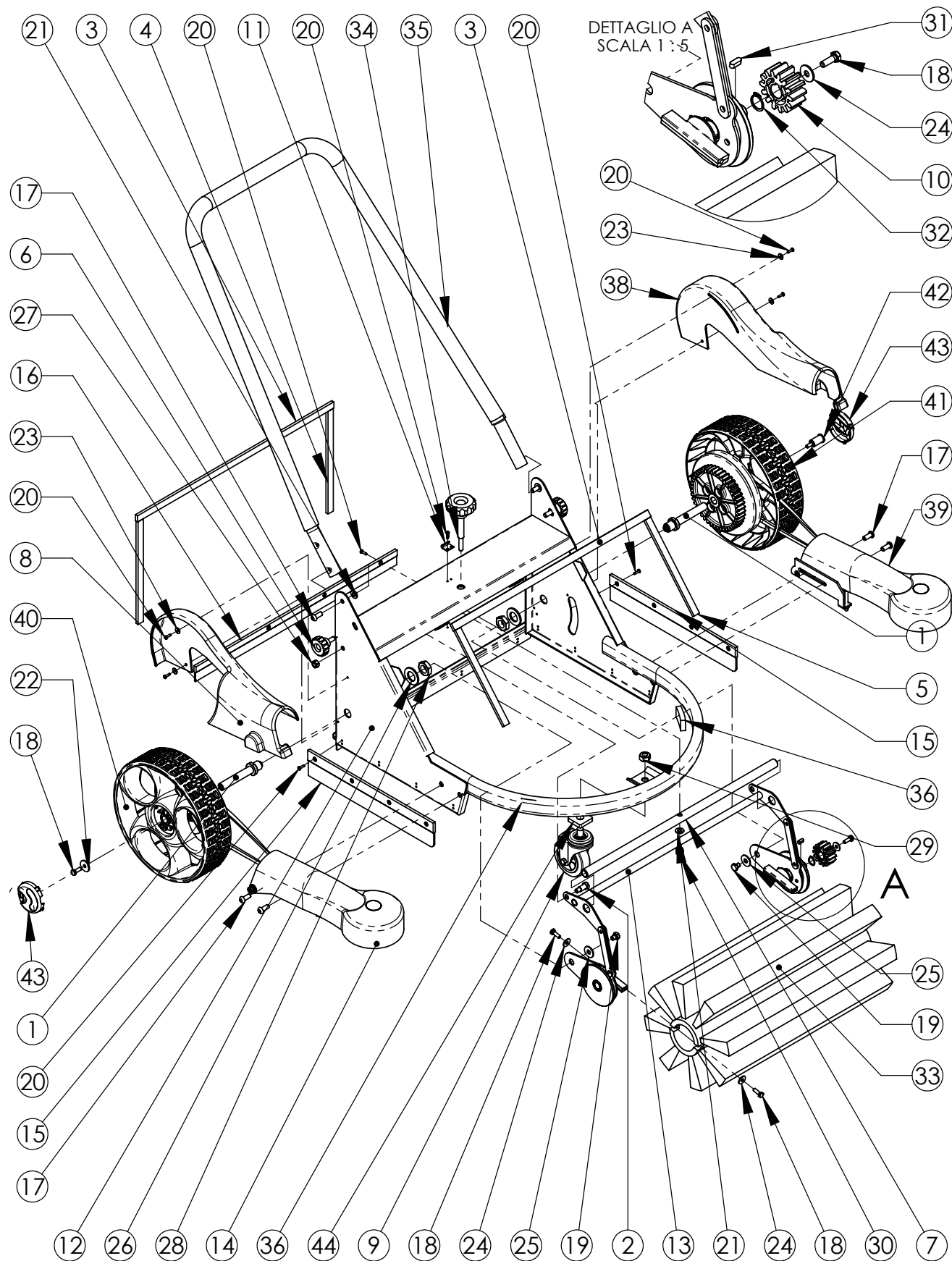

barredora Flash 950M | balayeuse Flash 950M | kermaschine Flash 950M

Pos.	Q.tà	Code	ITALIANO	ENGLISH	DEUTSCH	ESPAÑOL	FRANCAIS
1	2	1.002.27.003	Perno FLASH 650M	Pivot FLASH 650M	Stütze FLASH 650M	Gozne FLASH 650M	Pivot FLASH 650M
2	2	1.002.27.020	Perno	Pivot	Stütze	Gozne	Pivot
3	2	1.006.17.001	Guarnizione 15x6 L555	Gasket 15x6 L555	Dichtung 15x6 L555	Guarnición 15x6 L555	Garniture 15x6 L555
4	2	1.006.17.007	Guarnizione 15x6 L=245	Gasket 15x6 L=245	Dichtung 15x6 L=245	Guarnición 15x6 L=245	Garniture 15x6 L=245
5	2	1.006.17.008	Guarnizione 15x6 L=215	Gasket 15x6 L=215	Dichtung 15x6 L=215	Guarnición 15x6 L=215	Garniture 15x6 L=215
6	2	1.021.04.004	Manopola M8x20	Knob M8x20	Griff M8x20	Pomo M8x20	Poignée M8x20
7	1	1.044.27.001	Tube L=540	Pipe L=540	Rohr L=540	Tube L=540	Tuyau L=540
8	1	1.075.07.002	Carter Protezione FLASH 650M	Front Cover FLASH 650M	Frontalmantel FLASH 650M	Carter frontal FLASH 650M	Capot antérieur FLASH 650M
9	1	1.086.07.002	Ruota girevole ø80	Revolving wheel ø80	Drehbares Rad ø80	Rueda giratoria ø80	Roue pivotante ø80
10	1	1.122.07.001	Pignone Z14	Pinion Z14	Ritzel Z14	Piñón Z14	Pignon Z14
11	1	1.126.07.002	Gancio	Hook	Haken	Gancho	Crochet
12	1	2.015.07.002	Telaio FLASH 650M	Frame FLASH 650M	Rahmen FLASH 650M	Estructura FLASH 650M	Chassis FLASH 650M
13	1	2.065.17.001	Bilanciere FLASH 650M	Balance wheel FLASH 650M	Schwinghebel FLASH 650M	Balancín FLASH 650M	Balancier FLASH 650M
14	1	2.066.07.001	Braccio FLASH 650M	Arm FLASH 650M	Arm FLASH 650M	Brazo FLASH 650M	Bras FLASH 650M
15	2	2.075.07.001	Fascia Laterale FLASH 650M	Side Band FLASH 650M	Seitliche Band FLASH 650M	Faja lateral FLASH 650M	Bande latérale FLASH 650M
16	1	2.075.07.002	Fascia Posteriore FLASH 650M	Back band FLASH 650M	Hinter Band FLASH 650M	Faja Posterior FLASH 650M	Bande Postérieure FLASH 650M
17	6	4.002.14.024	Vite M8x20 ISO7380	Screw M8x20 ISO7380	Schrauben M8x20 ISO7380	Tornillo M8x20 ISO7380	Vis M8x20 ISO7380
18	6	4.002.44.003	Vite M6x18 UNI5739	Screw M6x18 UNI5739	Schrauben M6x18 UNI5739	Tornillo M6x18 UNI5739	Vis M6x18 UNI5739
19	2	4.002.47.005	Vite M8x10 UNI5739	Screw M8x10 UNI5739	Schrauben M8x10 UNI5739	Tornillo M8x10 UNI5739	Vis M8x10 UNI5739
20	18	4.002.94.022	Vite autofilettante 3.5x13 B	Self-tapping Screw 3.5x13 B	Selbschneidendeschraube 3.5x13 B	Tornillo autoblocante 3.5x13 B	Vis autofiletant 3.5x13 B
21	3	4.008.04.002	Rondella M8 UNI6592	Washer M8 UNI6592	Unterlegscheibe M8 UNI6592	Arandela M8 UNI6592	Rondelle M8 UNI6592
22	1	4.008.04.003	Rondella M6 UNI6593	Washer M6 UNI6593	Unterlegsscheibe M6 UNI6593	Arandela M6 UNI6593	Rondelle M6 UNI6593
23	4	4.008.07.003	Rondella ø4xø12x1	Washer ø4xø12x1	Unterlegscheibe ø4xø12x1	Arandela ø4xø12x1	Rondelle ø4xø12x1
24	5	4.008.24.001	Rondella M6 UNI6593	Washer M6 UNI6593	Unterlegscheibe M6 UNI6593	Arandela M6 UNI6593	Rondelle M6 UNI6593
25	2	4.008.24.002	Rondella ø8.5x24x2.5 6593	Washer ø8.5x24x2.5 6593	Unterlegscheibe ø8.5x24x2.5 6593	Arandela ø8.5x24x2.5 6593	Rondelle ø8.5x24x2.5 6593
26	2	4.008.24.003	Rondella M20 UNI6592	Washer M20 UNI6592	Unterlegscheibe M20 UNI6592	Arandela M20 UNI6592	Rondelle M20 UNI6592
27	2	4.009.02.002	Dado M8 UNI5588	Nut M8 UNI5588	Mutter M8 UNI5588	Dado M8 UNI5588	Ecrou M8 UNI5588
28	2	4.009.07.001	Dado M18 UNI 5589-65 ZEG	Nut M18 UNI 5589-65 ZEG	Mutter M18 UNI 5589-65 ZEG	Dado M18 UNI 5589-65 ZEG	Ecrou M18 UNI 5589-65 ZEG
29	1	4.009.07.002	Dado M12 UNI 5588-65	Nut M12 UNI 5588-65	Mutter M12 UNI 5588-65	Dado M12 UNI 5588-65	Ecrou M12 UNI 5588-65
30	1	4.009.14.001	Dado M8 UNI7473	Nut M8 UNI7473	Mutter M8 UNI7473	Dado M8 UNI7473	Ecrou M8 UNI7473
31	1	4.021.07.001	Chiavetta A 5x5x14 UNI 6604	Key A 5x5x14 UNI 6604	Keil A 5x5x14 UNI 6604	Chaveta A 5x5x14 UNI 6604	Clavette A 5x5x14 UNI 6604
32	1	4.025.07.002	Seeger A15 UNI 7435-75	Seeger A15 UNI 7435-75	Seeger A15 UNI 7435-75	Seeger A15 UNI 7435-75	Seeger A15 UNI 7435-75
33	1	4.065.07.002	Spazzola ø240x490 (8x0.4)	Brush ø240x490 (8x0.4)	Bürste ø240x490 (8x0.4)	Cepillo ø240x490 (8x0.4)	Brosse ø240x490 (8x0.4)
34	1	2.039.07.004	Manopola regolazione spazzola Flash950M	Knob adjustment brush Flash950M	Knopf Anpassung Pinsel Flash950M	Perilla de ajuste de pincel Flash950M	Bouton de réglage de brosse Flash950M
35	1	1.095.07.001	Manico	Handle	Griff	Manija	Manche
36	2	1.006.17.017	Guarnizione 50X10X25	Gasket 50X10X25	Dichtung 50X10X25	Guarnición 50X10X25	Garniture 50X10X25
38	1	1.075.07.008	Carter SX - FLASH650M-2	Guard SX - FLASH650M-2	Gehäuse SX - FLASH650M-2	Carter SX - FLASH650M-2	Carter SX - FLASH650M-2
39	1	2.066.07.004	Braccio (SX) FLASH950M	Arm (SX) FLASH950M	Arm (SX) FLASH950M	Brazo (SX) FLASH950M	Bras (SX) FLASH950M
40	1	2.054.07.007	Ruota Flash950M	Wheel Flash950M	Rad Flash950M	Rueda Flash950M	Roue Flash950M
41	1	2.054.07.008	Ruota Flash950M	Wheel Flash950M	Rad Flash950M	Rueda Flash950M	Roue Flash950M
42	1	1.002.27.029	Perno	Pivot	Stütze	Gozne	Pivot
43	2	1.085.07.003	Coprimozzo R	Hub Cap R	Nabe Haus R	Casquillo del cubo R	Enjoliveur de roue R
44	1	1.138.07.048	Piatto	Plate	Platte	Placa	Plaque

spazzatrice batteria Flash 650B-850B | battery-powered sweeper Flash 650B-850B
barredora Flash 650B-850B | balayeuse Flash 650B-850B | kermaschine Flash 650B-850B



spazzatrice batteria Flash 650B-850B | battery-powered sweeper Flash 650B-850B
barredora Flash 650B-850B | balayeuse Flash 650B-850B | kermaschine Flash 650B-850B



Richiedi la lista completa dei ricambi dell'esplosivo tecnico all'indirizzo info@bieffeitalia.it.
Saremo lieti di ricontattarti nel piu' breve tempo possibile.

Request the complete list of spare parts in the technical exploded view at info@bieffeitalia.it.
We will be assist you in the shortest, possible time.



su richiesta e' possibile avere componenti non presenti a catalogo



LINEA STIRO



LINEA PULITO



LINEA AUTOMEZZI



BIEFFE®
FARINELLI
GENERATORI DI VAPORE

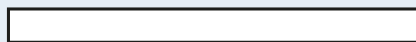

LINEA PULIZIA SCARPE



LINEA SANIFICAZIONE



LINEA SPAZZATRICI



LINEA PULITO

Per una professionale pulizia a vapore



Scarica il catalogo e le
schede tecniche
Download our catalogue
and technical file

CLEANING LINE

Professional steam cleaning

Macchine a vapore progettate per la pulizia e sanificazione di abitazioni private, locali pubblici e professionali quali ristoranti, panifici, laboratori alimentari, alberghi, centri commerciali, ma anche per la pulizia di tappezzeria, divani, materassi, poltrone.

Steam generators designed for cleaning and sanitizing private places, public and professional areas such as restaurants, bakery shops, food laboratories, hotels, and shopping centers, as well as for cleaning upholstery, sofas, mattresses, and more.

Ricarica automatica o manuale

Automatic or manual boiler refill

Iniezione/estrazione vapore

Steam injection/extraction

Iniezione/estrazione acqua calda e detergente

Warm water and detergent injection/

Aspiraliquidi

Wet&dry vacuum cleaner



• EMILIO

- BF089E
- BF089EPL
- BF089RE
- BF089REPL



CLEAN VAPOR JUNIOR BF090JN



CLEAN VAPOR BF090E



SPAZZATRICI

SWEEPERS



Scarica il catalogo e le
schede tecniche
Download our catalogue
and technical file

Le spazzatrici a funzionamento elettrico e manuale, rappresentano soluzioni ideali per la pulizia sia negli ambienti interni, come officine, magazzini, centri commerciali e negozi, sia negli spazi esterni, come piazzali, cortili e vialetti. Sono leggere e maneggevoli e sono in grado di raccogliere efficacemente qualsiasi tipo di sporco presente sulle superfici, che sia polvere, foglie, aghi di pino, coriandoli, brecciolina o oggetti più voluminosi, garantendo così un risultato impeccabile su ogni tipo di pavimentazione.

Electric and manual sweepers are ideal for cleaning indoor environments, such as workshops, warehouses, shopping malls, and shops, and outdoor spaces, such as courtyards, sidewalks, and driveways. They are lightweight and easy to handle, capable of effectively collecting any dirt present on surfaces, including dust, leaves, pine needles, confetti, gravel, or larger objects, ensuring impeccable results on all types of flooring.

Doppia o singola spazzola
Double or single brush

Spazzola centrale
Central brush

Ambienti fino a 2800 m²
Area up to 2800 m²

Contenitori rifiuti facili da svuotare
Easy-to-empty waste containers

A BATTERIA

Battery powered

FLASH
BF850B



FLASH
BF650B



MANUALE

Manual

FLASH
BF650M



FLASH
BF950M



LINEA MEDICALE

Generatori di vapore per pulizia e sanificazione di studi medici

MEDICAL LINE

Steam generators for cleaning and sanitizing medical clinics



Scarica il catalogo e le
schede tecniche
Download our catalogue
and technical file

Generatori di vapore specifici per la pulizia e sanificazione di strumenti e studi medici/dentistici. Grazie alla sua alta temperatura e al potente getto, il vapore è in grado di pulire e sanificare le strumentazioni dentistiche, poltrone, postazioni oltre a neutralizzare efficacemente germi, batteri, muffe, funghi, e odori.

Steam generators are specifically designed for cleaning and sanitizing medical and dental instruments and clinics. Thanks to the high temperature of the steam and the powerful jet, it can clean and sanitize dental instruments, chairs, and workstations, effectively neutralizing germs, bacteria, molds, fungi, and odors.

**Ricarica automatica/manuale/
collegamento rete idrica**

*Automatic or manual boiler refill/
water supply connection*

Regolazione acqua/vapore/pressione

Water/steam/pressure adjustment

Iniezione acqua calda e vapore

Warm water and steam injection



**MAGIC
VAPOR RA
3kW**
BF009PL



**MAGIC VAPOR RA
3kW DENTAL**
BF009PL3



VAPORDENT SENIOR

- BF450RM000
- BF450RA000
- BF450RI000



VAPORDENT JUNIOR

- BF009PVRM0
- BF009PV000



LINEA PULIZIA SCARPE

Generatori di vapore per ricondizionare scarpe e accessori



Scarica il catalogo e le
schede tecniche
Download our catalogue
and technical file

CLEANING SHOES LINE

Steam generators to recondition shoes and accessories

Generatore di vapore professionale per la pulizia di scarpe, borse, accessori, caschi e molto altro. Con le macchine Scarpavapor è possibile erogare vapore, schiuma e detergente, ricondizionando scarpe e accessori. Ideale per lavanderie e calzolai.

Professional steam generator for cleaning shoes, bags, accessories, helmets, and much more. With Scarpavapor machines, you can dispense steam, foam, and detergent. Ideal for laundries and shoemakers.

Pulizia completa con vapore
Complete steam cleaning

Ricarica automatica della caldaia
Automatic boiler refill

Erogazione detergente e schiuma
Steam and detergent injection

Asciugatura con aria calda a 36°C
warm air drying at 36°C

Vano dedicato per asciugatura di giacche
Dryer space for jackets

Aspirazione
vacuum

Igienizzazione con ozono
Ozone sanitization



**BANCO DA LAVORO
ASPIRANTE CON LUCE**
RIP2010



**SCARPAVAPOR
PLUS**
BFX426S



SCARPAVAPOR NO LIMITS
BF426S



SCARPAVAPOR
BF425S



DRY CABIN
BF380

LINEA AUTOMEZZI

Per sanificare, pulire, ricondizionare gli automezzi



Scarica il catalogo e le
schede tecniche
Download our catalogue
and technical file

MOTOR VEHICLE LINE

To sanitize, clean and recondition vehicles

Attrezzatura per il ricondizionamento a vapore degli interni ed esterni dei veicoli. Ideali per pulizia e sanificazione degli interni delle auto, autobus e pullman, treni, furgoni, camper e per la pulizia della carrozzeria. Trovano ampio utilizzo in autolavaggi, carrozzerie, car detailing, officine meccaniche e anche per servizi a domicilio.

Equipment for steam cleaning of the interiors and exteriors of vehicles. Ideal for cleaning and sanitizing the interiors of cars, buses, coaches, trains, vans, campers, and for cleaning the bodywork. They are widely used in car washes, body shops, car detailing, mechanical workshops, and also for mobile services.

Ricarica automatica o manuale
Automatic or manual boiler refill

Iniezione/estrazione vapore
Steam injection/extraction

Iniezione/estrazione acqua calda e detergente
Warm water and detergent injection/extraction

Aspirazione
vacuum cleaner

Sanificazione ad ozono
ozone sanitizing

Asciugatura con aria calda
warm air drying

VAPOBUS BF090JB



EXTRACTO FOAM PLUS BF429A/B



**BF4000
VAPOR**
BF601



**BF4000
VACUUM**
BF602

ASPIRATORE SOLIDI/LIQUIDI

*Wet&dry vacuum
cleaner*

- 15, 23, 62 lt
- 1, 2, 3 motori/motors



CARFON
BF350

CARWASH 380V

- BF310PL
- *BF310PLZ*
con ozono
w/ozone



CARWASH

- BF310
- *BF310Z*
con ozono
w/ozone



MAGIC CAR
BF009CAR

STEAM CAR
BF420C

LINEA STIRO

Ferri da stiro con caldaia professionali e per la casa



Scarica il catalogo e le
schede tecniche
Download our catalogue
and technical file

IRONING LINE

Professional and domestic steam irons

Ferri da stiro professionali e per la casa, dotati di un generatore di vapore con caldaia in rame. Ideali per abitazioni private, sartorie, tintorie, laboratori di confezioni, alberghi.

Professional and home steam irons, equipped with a steam generator with copper boiler. Ideal for private homes, tailors, dry cleaners, clothing workshops, and hotels.

BABY VAPOR 2 LT

BF001 | BF010



BIANCO



INOX



SUPER VAPOR 2 LT

BF023



SUPER VAPOR PLUS 2,4 LT

BF072 | BF073



BIANCO



INOX



MAGIC VAPOR 2,8 LT

BF005 | BF002



BIANCO



INOX



MAXI VAPOR 3,5 LT

BF004 | BF003



BIANCO



INOX



MAXI VAPOR PLUS 5 LT

BF04P | BF03P



BIANCO



INOX



AUTOMATIC VAPOR PLUS 2,8 LT

BF049



EASY VAPOR 2,4 LT

BF0016



STIR VAPOR 1,5 L BF054



INOX



GIALLO



ROSSO



AVORIO



BLU



BIANCO

**AUTOMATIC
VAPOR 2,8 LT**
BF048



**AUTOMATIC
VAPOR 3kW
2,8 LT**
2 FERRI/2 irons
BF048C2V



**STEAM
IRON**
5 LT 380V
BF425S02



LINEA STIRO

Tavoli professionali

IRONING

Professional ironing board



Scarica il catalogo e le
schede tecniche

Download our catalogue
and technical file

Tavoli da stiro professionali, dotati di un piano da lavoro aspirante e riscaldato (a scelta anche soffiante), caldaia con ricarica manuale o automatica, e di regolazione della temperatura. Ideali per l'utilizzo in lavanderie, sartorie, tintorie, laboratori di confezioni, alberghi e anche in ambito domestico.

Professional ironing tables, equipped with a vacuum and heated work surface (optionally also blower), boiler with manual or automatic refill of the water, and temperature adjustment. Ideal for use in laundries, tailors, dry cleaners, clothing workshops, and hotels, as well as at home.

**ASSE
DA STIRO**
Ironing board
BF006



**ASSE DA STIRO
CON CALDAIA
2LT**
BF070
Ironing board
w/boiler



NEW JOLLY
• BF091
• BF291 SOFFIANTE/blowing



**FOREVER
SENZA CALDAIA**
BF080
w/o boiler



FOREVER ASSE DA STIRO CON CALDAIA

2,8 LT

BF085

CON RICARICA AUTOMATICA
w/automatic refill



FOREVER ASSE DA STIRO CON CALDAIA

3,5 LT

BF084

Ironing board w/boiler



FOREVER RETTANGOLARE
51x129cm

- BF115
senza caldaia
w/o boiler
- BF086
con caldaia e ferro
w/boiler and iron
- BF205
con caldaia a ricarica
automatica e ferro
w/automatic boiler
refill and iron



ASSE DA STIRO RETTANGOLARE
112x50cm

BF026



FOREVER RETTANGOLARE
81x151cm

- BF210
senza caldaia
w/o boiler
- BF212
con caldaia e ferro
w/boiler and iron
- BF214
con caldaia a ricarica
automatica e ferro
w/automatic boiler
refill and iron



LINEA SANIFICAZIONE

Generatori di vapore e macchinari per la sanificazione



Scarica il catalogo e le
schede tecniche
Download our catalogue
and technical file

SANITIZATION LINE

Steam generator and sanitizing machinery

Macchinari a vapore per la pulizia dei condizionatori d'aria e di studi medici, nebulizzatori e generatori di ozono per la sanificazione di ambienti chiusi.

Steam machinery for cleaning air conditioners and medical facilities, nebulizers, and ozone generators for sanitizing enclosed spaces.

Pulizia completa anche nei punti nascosti

Complete cleaning even in hidden places

Sanificazione con ozono

Sanitization with ozone

Sanificazione con nebulizzatori di liquido igienizzante

Sanitization with sanitizing liquid nebulizers

Sanificazione con miscela vapore e igienizzante

Sanitization with steam mixture and sanitizing

Erogazione vapore e acqua per condizionatori

Steam and water supply for air conditioners

ARIASANA
BF651



SANIFICATORE OZONO

BF360



OZONO BIEFFE PLUS

BF360PL



MAGIC VAPOR SANI

BF009SANI



SANIBLASTER

BF370



CONDIZIONI GENERALI DI VENDITA - GENERAL TERMS OF SALE

1 - La merce viaggia a rischio e pericolo del committente anche quando è venduta a francodestino, non si risponde di ritardi ed eventuali ammanchi che possono verificarsi durante il viaggio, spetta al committente fare gli eventuali reclami ai vettori responsabili.

2 - Il termine di consegna previsto è valido solo per normali periodi di lavoro e prescinde da eventi di forza maggiore. In nessun caso accetteremo alcuna responsabilità derivante da eventuali ritardi.

3 - Gli eventuali reclami dovranno essere notificati entro otto giorni dal ricevimento della merce, per iscritto. I resi saranno da noi respinti in mancanza di nostra autorizzazione. Eventuali resi solo in porto franco.

4 - La merce resta di nostra proprietà fino a quando la fattura non sia stata interamente pagata. I pagamenti devono essere effettuati entro i termini indicati sulla fattura.

5 - I prezzi da noi confermati potranno essere modificati a causa di variazione nei costi di produzione (materie prime, manodopera, ecc.) senza l'obbligo di comunicazione scritta da parte nostra che comunque, quando possibile, sarà sempre ns. premura inviare.

6 - I prezzi da noi confermati si intendono al netto di qualsiasi spesa (imballo, spese bancarie, spese amministrative, ecc.)

7 - Alcuni prodotti sono vendibili solo a quantità o metrature minime.

8 - Per motivi di produzione i dati e le caratteristiche tecniche possono variare senza preavviso; le foto dei prodotti non sono vincolanti.

9 - Condizioni di vendita consultabili all'indirizzo www.bieffeitalia.it/termini-e-condizioni/

1 - Goods are carried at the consignee's risk, even if delivered free destination is not responsible for any delays, damages or losses occurred during the transportation. Consignee should submit and address any claims to carrier.

2 - The foreseen delivery term is valid only for normal periods of works and excludes events due to force majeure. In no case will accept any responsibility whatsoever resulting from possible delays.

3 - Notification of possible claims must be given by written letter within eight days of receipt of the goods. Goods returned shall be refused by us in default of our written authorization. Any returns can be accepted only free our warehouse.

4 - The goods remain of our property up to the moment of full payment of the invoice. The payments must be fulfilled within the terms written on invoices.

5 - The prices confirmed by us may be altered as a result of fluctuations in our production costs (raw materials, labour, etc.) without our being obliged to give written notice to that effect; we shall, however, take care to send such notification whenever possible.

6 - The prices confirmed by us are net of any expenses (packing, bank charges, administrations expenses, etc.).

7 - Some items are sold by minimum quantity or meters.

8 - For production reasons data and technical characteristics can change without previous information; products photos are not constraining.

9 - Terms and conditions available at www.bieffeitalia.it/termini-e-condizioni/

LA FORZA DEL VAPORE

